

ECO
Pair PLUS

Single Room
Energy Recovery Ventilator

Breathe easy,
live sustainably with Eco-Pair Plus



You Have Building Project, **We Have Your Ventilation.**







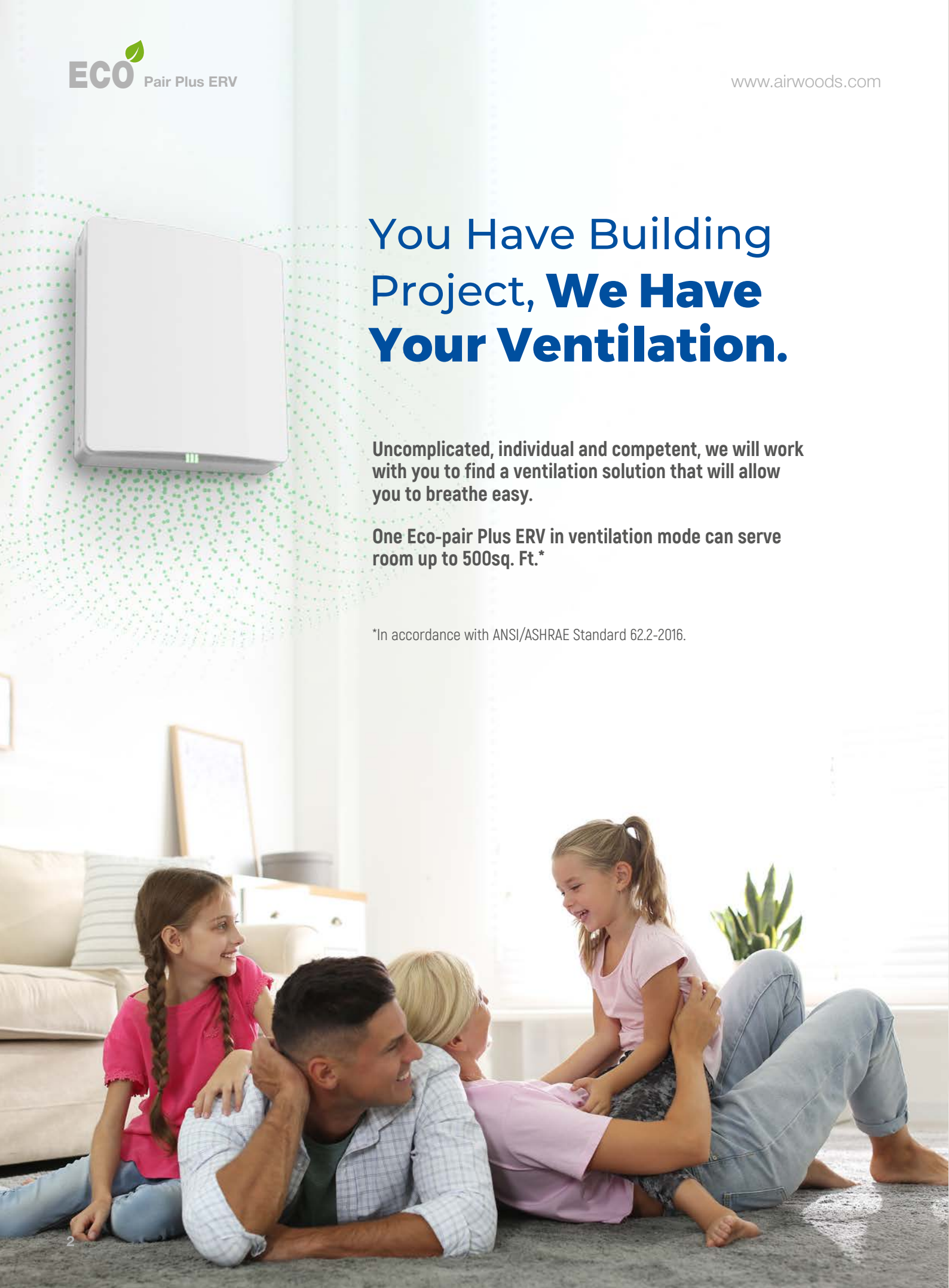







Uncomplicated, individual and competent, we will work with you to find a ventilation solution that will allow you to breathe easy.

One Eco-pair Plus ERV in ventilation mode can serve room up to 500sq. Ft.*

*In accordance with ANSI/ASHRAE Standard 62.2-2016.



Features

-  Elegant decorative front panel.
-  Automatic shutter to prevent back draught.
-  Frost and condensation free.
-  One-stop installation through the internal wall with a single hole.
-  High thermal efficiency. Built-in high-tech ceramic energy regenerator with maximum heat recovery efficiency of 97%.
-  Reversible 3 speed EC duct fan with low power consumption of 7.8W.
-  Free-cooling: when the unit detects that the outdoor temperature is within $\pm 1^{\circ}\text{C}$ of the set temperature, it automatically switches to supply more fresh air.
-  Prefilter and F7 (MERV11) filter as standard to keep air clean.
-  Flexible operation, working individually or in pairs.
-  High ingress protection with IPX4.
-  Quiet operation of less than 32.7dB(A).
-  Easy control. Unit can be controlled via button, remote controller and WIFI (Smart APP). With APP, user also can create scene control and group control.
-  Controlled by Android or iOS smartphone via the cloud server from anywhere in the world.
-  Smarter IAQ control. Standard CO2 sensor to display real-time concentration and controls the unit to supply more fresh air to dilute the CO2 concentration, and optional humidity sensor and IAQ detector.

Elegant Decorative Front Panel



- ▶ The specially designed indoor unit can be magnetically connected to ensure maximum air tightness and protection against wind.

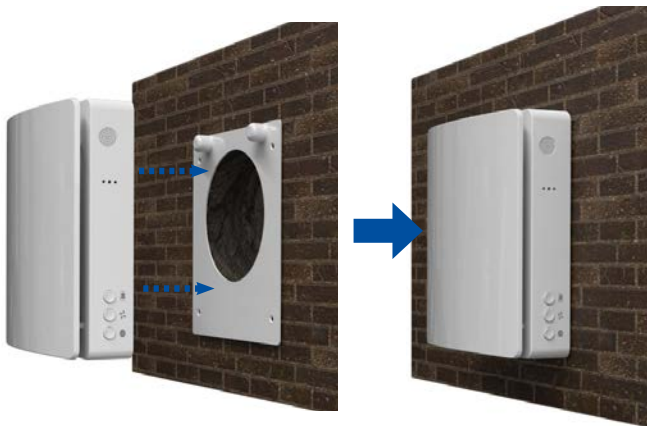

- ▶ Built-in auto shutter prevents air back draught.

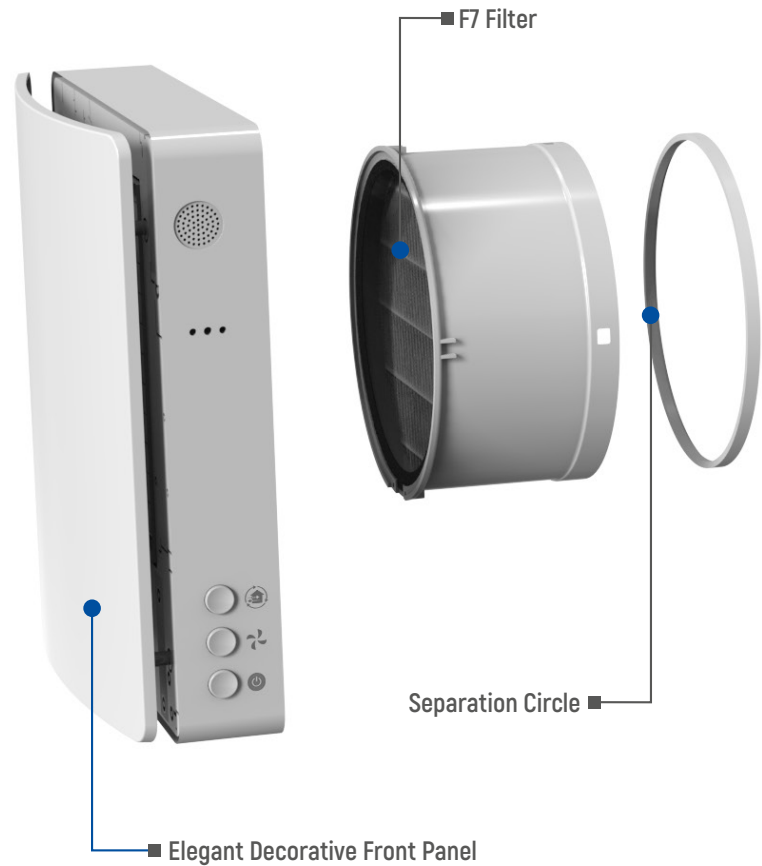
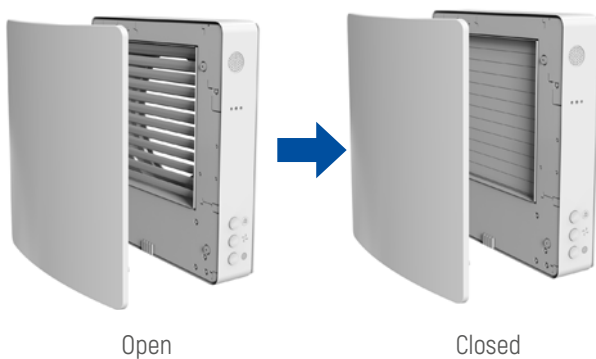

Reversible DC Motor

The reversible axial fan is with EC technology. The fan is characterised by low power consumption and silent operation. The fan motor has built-in thermal protection and ball bearings for long life.

Ceramic Energy Regenerator

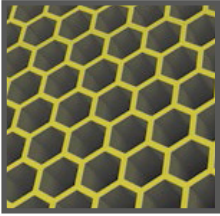

The high-tech ceramic energy accumulator with a regeneration efficiency of up to 97% ensures heat recovery from the exhaust air to heat or cool the supply air flow. Due to its cellular structure, the unique regenerator has a large air contact surface and high heat conducting and accumulating properties.

The ceramic regenerator is treated with an antibacterial composition to prevent bacterial growth inside.

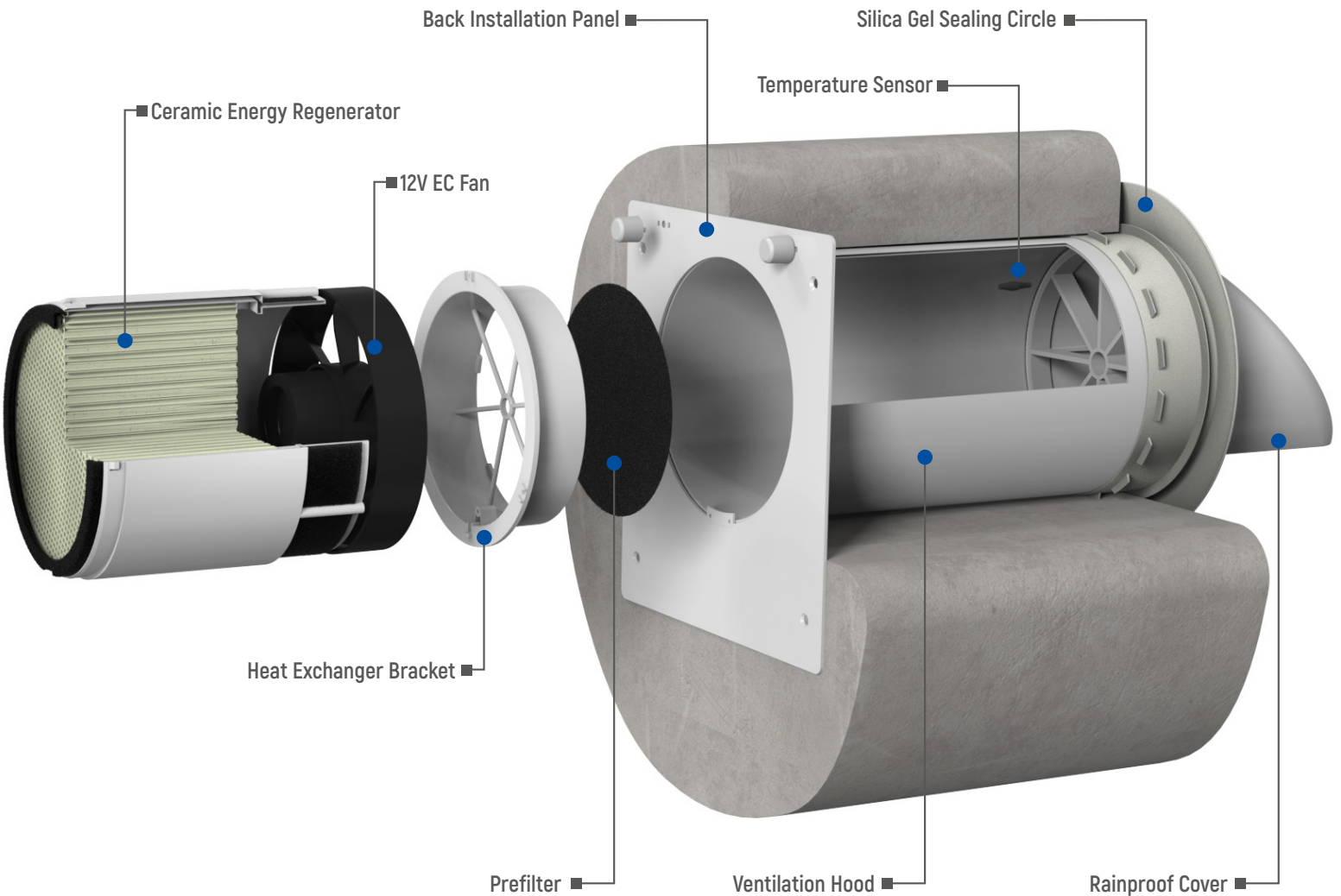

Air Filters

Two integrated air pre-filters and a F7 air filter are fitted as standard to provide supply and extract air filtration. The filters prevent the ingress of dust and insects into the supply air and contamination of the fan parts. The filters are also antibacterially treated.

The filters are cleaned with a vacuum cleaner or by flushing with water. The antibacterial solution will not be removed.

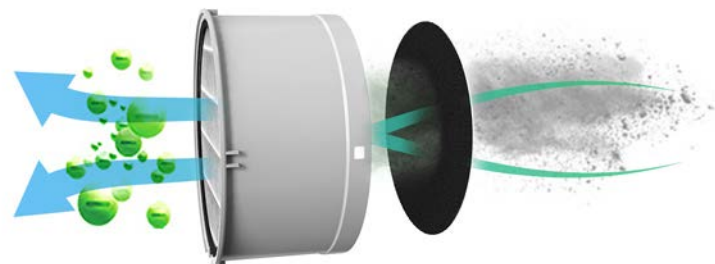

Energy Saving

The ventilator is designed both for reversible mode with energy regeneration and supply or exhaust mode with no regeneration.

WHEN IT'S COOL OUTSIDE:

The ventilator operates in the heat recovery mode with two cycles can save energy by over 30% compared with the normal exhaust fan. The heat recovery efficiency is up to 97% when the air first entering the heat regenerator. It can recover the energy in the room and reduce the load on the heating system in winter.



Energy Recovery

WHEN IT'S HOT OUTSIDE

The ventilator operates in the heat recovery mode with two cycles. Two units intake/exhaust air alternately at the same time to achieve balance ventilation. It will increase the indoor comfort and make ventilation more effective. The heat and humidity in the room can be recovered during ventilating and the load on cooling system can be reduced in summer

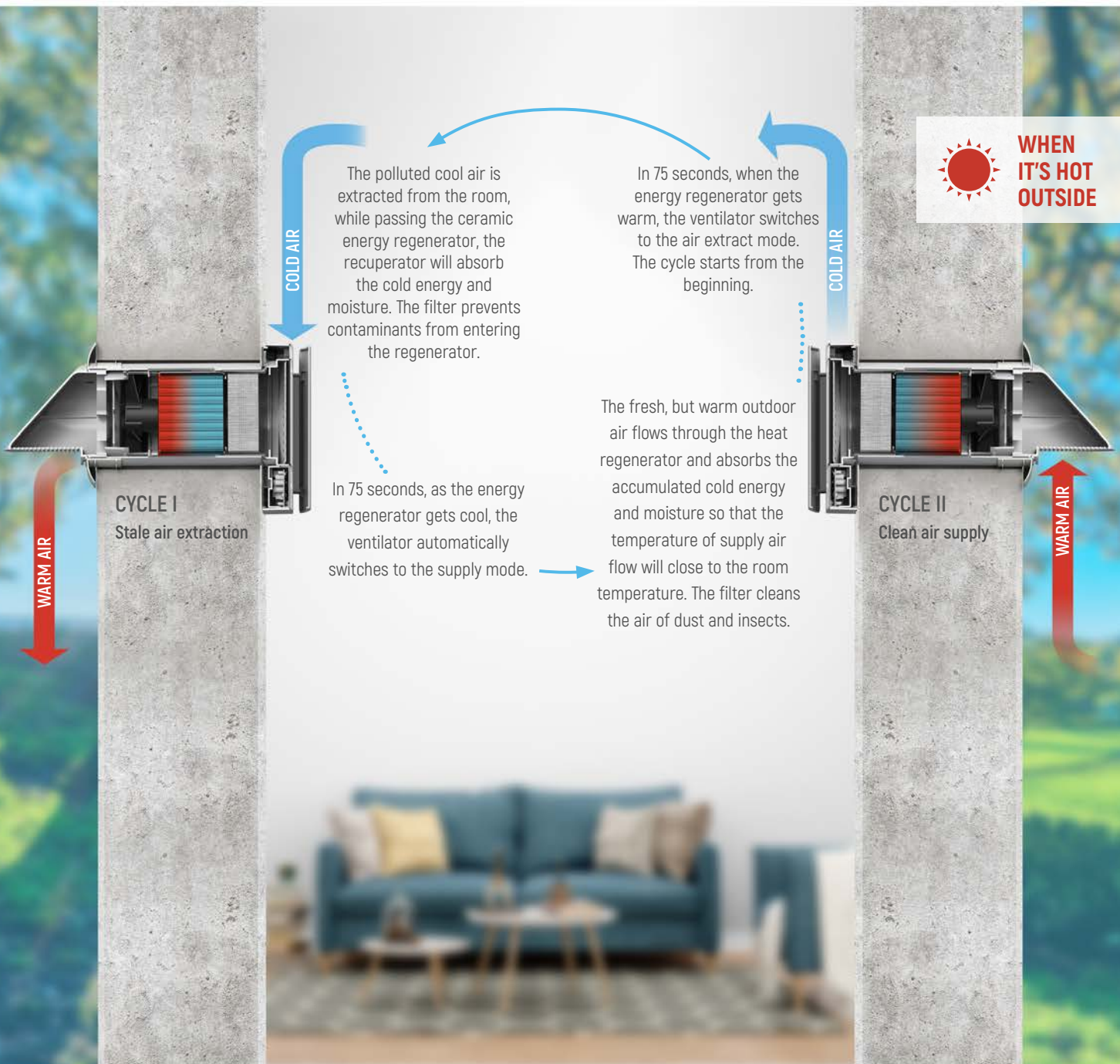

Easy Control

Button

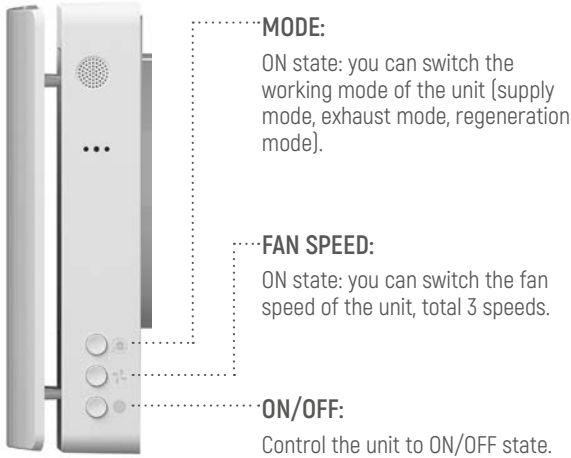

WiFi Function

- ▶ On/off switch
- ▶ Fan speed selection
- ▶ Working mode selection
- ▶ Pairing status
- ▶ Outdoor temperature display
- ▶ Filter alarm
- ▶ Free-Cooling function
- ▶ CO2 concentration control
- ▶ 12 hrs timer setting
- ▶ Optional Negative ion function
- ▶ Indicator lights ON/OFF
- ▶ Weekly schedule
- ▶ Fan boost function
- ▶ Multiple linkage control
- ▶ Smart control according to local weather
- ▶ Optional humidity control

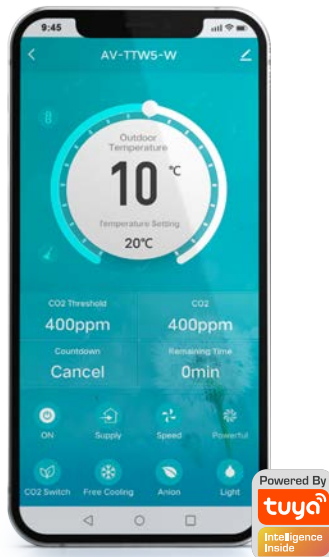

The app is available on the App Store and Google Play.



Work with Alexa and Google Assistant.



Remote Control

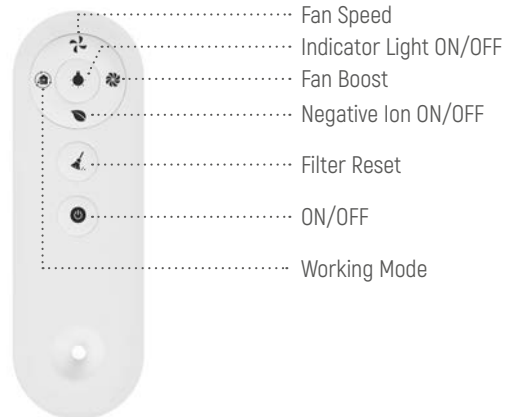

- ▶ Using radio signal for communication.
- ▶ Longer distances communication up to 15m without barrier.
- ▶ Wider control area, multiple devices can be controlled at the same time.
- ▶ Accurate control to avoid controlling the wrong device.

SCENE CONTROL

User can create scene(s) according to the weather changes, schedule or the device status changes.

For example, when the weather shows the outdoor relative humidity is higher than 85%, user can set the ventilator to stop or run at exhaust mode, to prevent the outdoor humidity coming inside. The unit will run according to the setting automatically.



Group Control

The ventilator can create group control at the APP, the quantity is not limited. User can control all the ventilators in the group easily.

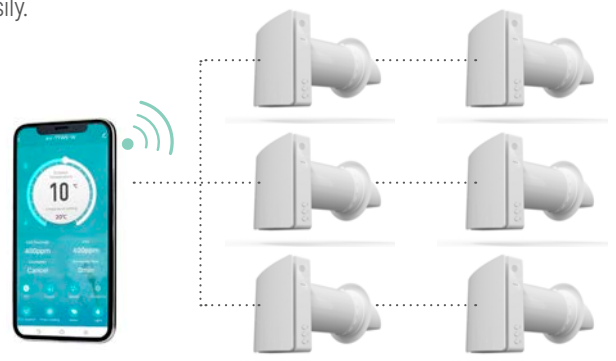

Wireless Operation In Pair To Ensure Balanced Ventilation

One ERV supplies fresh air for 75s, while the other ERV extracts indoor stale air for 75s, to achieve a balanced ventilation system.



WIRELESS CONNECTION OF MASTER AND SLAVE UNIT

NO WIRING OR DIALING NEEDED

30 METERS ULTRA LONG DISTANCE TRANSMISSION

* 30 meters was tested without barrier and interference. In practical application, it is recommended to install within 8-15 meters. Please avoid strong interference sources and shielding objects (e.g. iron frames, aluminum ceiling).

Energy Saving And Improve Indoor Air Comfort



FREE COOLING

Eco-pair plus is equipped with a temperature sensor as standard. When the outdoor air is comfortable, it will work in supply mode to introduce fresh air without heat recovery, it's called free cooling. When the unit detects the outdoor temperature is within $\pm 1^{\circ}\text{C}$ of the set temperature, it will automatically switch to supply mode to supply more fresh air.

CO2 CONTROL

Eco-pair plus is equipped with a CO2 sensor (optional with humidity sensor) as standard, when the ERV works in regeneration mode, if the indoor CO2 exceeds the set CO2 values, the ERV will automatically switch to supply mode until the CO2 value is lower than the set value.

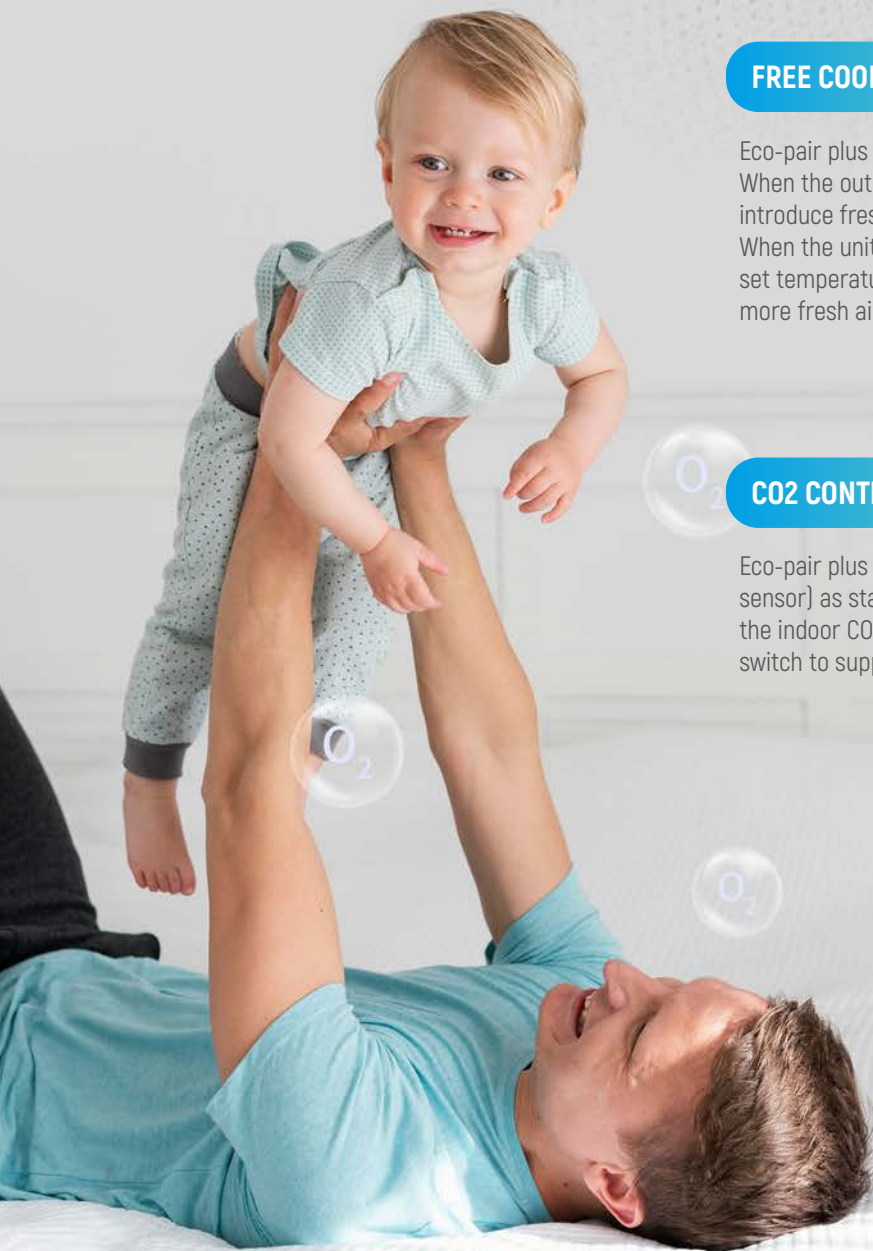

Technical Parameters

Model No.	AV-TTW5-W		
Voltage	100V~240V AC /50-60Hz		
Power (W)	6	7	7.8
Current (A)	0.04	0.05	0.06
Air flow in supply/exhaust mode (with F7 filter) (CMH/CFM)*	20/11.8	40/23.5	50/29.4
Max airflow (under fan boost mode) (CMH/CFM)	60/35.3		
Sound pressure level (dBA)	32.7		
Regeneration efficiency	Up to 97%		
SEC	Class A		
Ingress protection rating	IPX4		
RPM (max)	2200		
Diameter of duct (mm)	158		
Product size (mm)	239.6x258x499.7 (The length of duct in wall is 280-470 mm)		
Net Weight (kg)	4.2		

*Note: The airflow in supply/exhaust mode without F7 filter is about 34/56/70CMH or 20/33/41.2 CFM, and the relative parameters will be adjusted accordingly.

Dimensions

(Unit: mm)

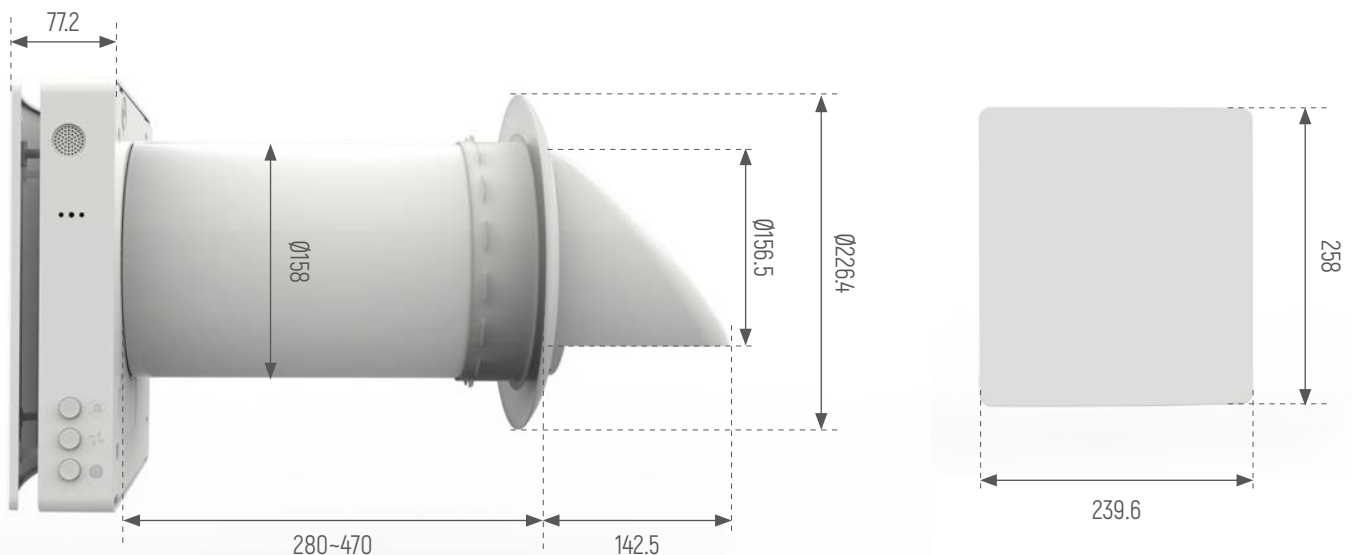

Accessories

PICTURE	ACCESSORY NAME	PRODUCT CODE	PICTURE	ACCESSORY NAME	PRODUCT CODE
	Kit for the thin wall	AS-KTW001		Stainless steel round grille	AS-SRG001
	Extended pipe (Ø 160, Length 390mm, to extend the total pipe length to 600mm)	AS-EDP001		Indoor unit	AS-IUN001
	Ventilation hood for indoor mounting	AS-VHI001		Cartridge with regenerator, fan and two filters	AS-CRF001
	Metal outer hood with electrical heater	AS-MHE001		Prefilter	AS-PFN001
	Metal outer hood	AS-MHN001		F7 (MERV11) filter	AS-F7F001
	Plastic square grille	AS-PSG001		Remote control	QB09-IR-PYJ02
	Plastic round grille	AS-PRG001		Smart air quality detector	AS-AQ10Z-1



*Breathe easy,
live sustainably with Eco-Pair Plus*



Guangzhou Airwoods Environment Technology Co., Ltd.

2101, Tower 25 Headquarter Center, Tian An Park, 555 Panyu Ave., Guangzhou, China

Tel: +86-20-39141701 E-mail: info@airwoods.com Website: www.airwoods.com

