

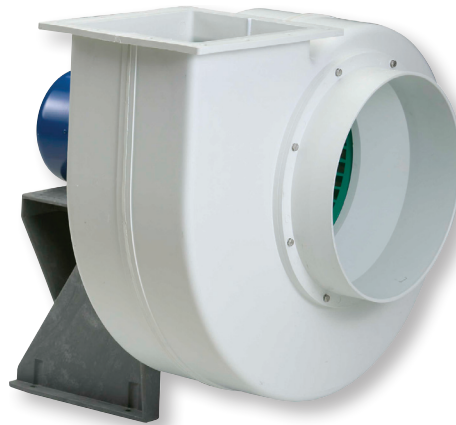

Circular outlet version



Rectangular outlet version



Rectangular outlet version  
Models 50, 60 and 70

Range of single inlet direct drive centrifugal fans manufactured from tough injection moulded polypropylene plastic, motor support and designed for extraction of corrosive fumes. All the fans are provided with forward curved centrifugal impellers manufactured from injection moulded polypropylene plastic. Available, depending upon the model, with single or three phase motors in 2, 4, 6 or 8 poles. Working temperature from -10 to 60 °C.

**Motors**

All motors are IP55, class F insulation. Electrical supply:  
Single phase 230V-50Hz up to 1,1 kW.  
Three phase 230/400V-50Hz.  
Three-phase motor speed controllable by inverter.  
(See characteristics chart).

**Additional information**

The mounting frames are manufactured from:  
- Nylon (models from 14 to 25)  
- Polypropylene (models 30 and 35)  
- Galvanised sheet steel (model 42 to 70)  
Standard supplied position: LG 0.  
The scroll can be orientated in 8 different positions. Screws in stainless steel.

**On request**

Fan supplied in RD positions. (Except models 14, 20A and 30A).  
Two speed motors.  
Scroll fitted with a permanent drain to evacuate condensation water.  
ATEX version (see CMPT ATEX series).

**Specific application**



Corrosive atmospheres

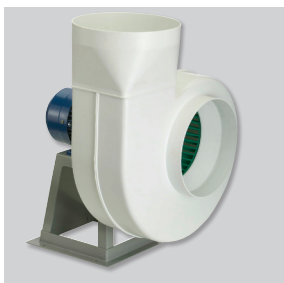

**Circular outlet duct connection**  
For models up to CMPT-30 and CMPT-25M.

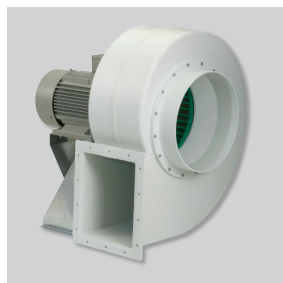

**Rectangular outlet duct connection**  
For models CMPT-35 and CMPT-42, CMPT-20A, CMPT-25A and CMPT-30A.

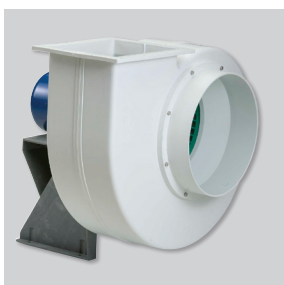

**Though and quality design**  
Tough Injection moulded polypropylene plastic. Screws in stainless steel.



**Forward curved centrifugal impeller**  
Forward curved centrifugal impeller manufactured from injection moulded polypropylene plastic.

**POSITIONS**

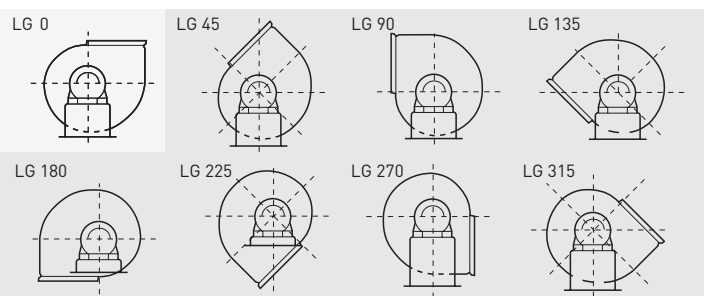

LG 0 standard supplied position. Other LG positions and RD configuration manufactured on request.

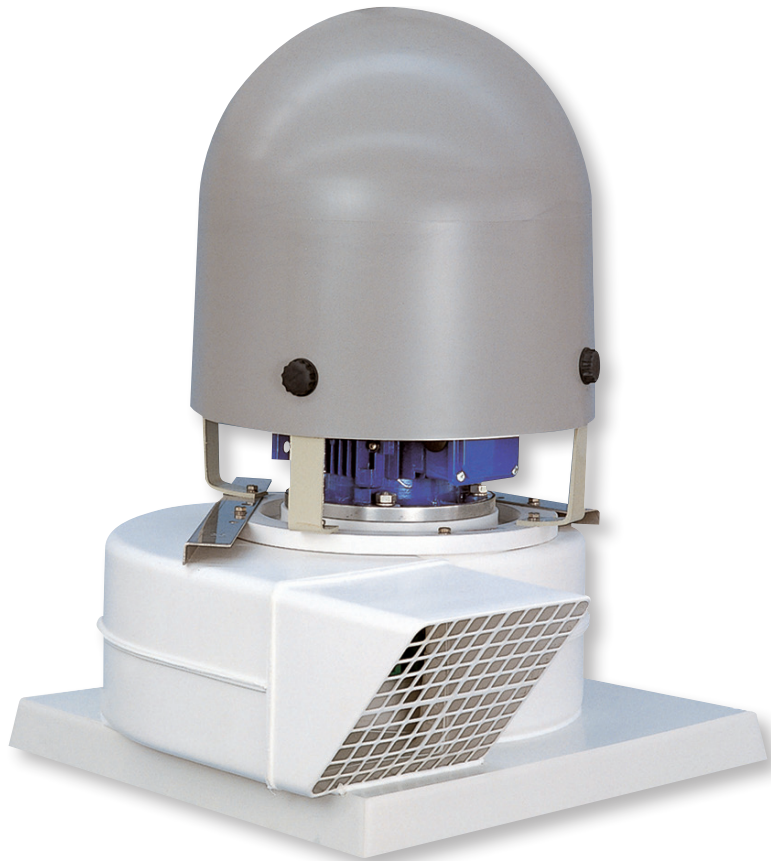

Centrifugal roof fan with forward curved impeller. Scroll manufactured from injected moulded polypropylene UV resistant. Wheel manufactured from injection moulded polypropylene plastic with retaining hub. Cowl manufactured from polypropylene UV resistant. Screws in stainless steel. Working temperature from -10 to 60 °C.

**Motors**

Three phase motors 230/400V or 400V 50Hz (TMPT) or single phase 230V-50Hz (TMPB), IP55, Class F, direct driven.

**Specific applications**



Corrosive atmospheres

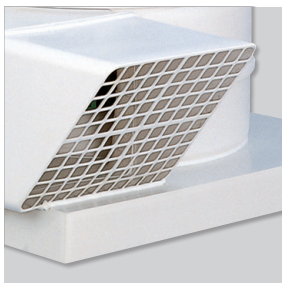

**Discharge protection**  
Discharge protection guard incorporated.

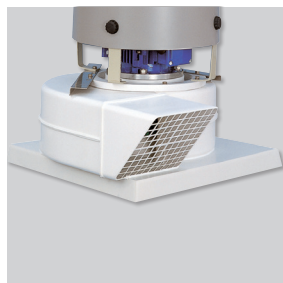

**Support base**  
Plastic base to ease the installation on the roof.

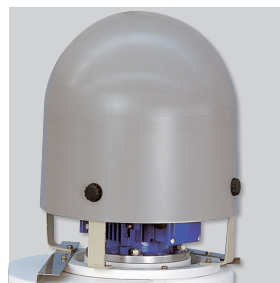

**Motor cowl**  
Plastic motor cowl to protect the motor.

**TECHNICAL CHARACTERISTICS CMPB / CMPT**

Before installation check that the product electrical characteristics listed on the data plate label (voltage, power, frequency, etc.) match those of the intended electrical supply.

Model	Speed (rpm)	Motor size (mm)	Nominal motor power (kW)	Nominal current (A)		Maximum airflow (m³/h)	Sound pressure level* (dB(A))	Weight (kg)
				230 V	400 V			
SINGLE PHASE 2 POLE								
CMPB/2-14-0,18	2900	63	0,18	1,53	-	730	60	4,5
CMPB/2-20-1,1	2900	80	1,1	7,9	-	2.100	72	13
CMPB/2-20A-0,55	2900	71	0,55	4,21	-	900	68	11
SINGLE PHASE 4 POLE								
CMPB/4-14-0,18	1470	63	0,05**	0,25	-	350	45	4,5
CMPB/4-20-0,12	1450	63	0,12	1,2	-	1.220	60	8
CMPB/4-23-0,55	1450	80	0,55	1,7	-	2.560	64	15
CMPB/4-24-0,55	1450	80	0,55	1,7	-	2.400	61	15
CMPB/4-25-0,55	1450	80	0,55	1,7	-	2.680	60	15
CMPB/4-30-1,1	1420	90	1,1	7	-	4.240	69	29
CMPB/4-25M-0,55	1450	80	0,55	1,7	-	1.700	63	15
CMPB/4-20A-0,12	1450	63	0,12	0,5	-	530	54	9
CMPB/4-25A-0,25	1430	71	0,25	2,1	-	1.100	66	10
CMPB/4-30A-0,55	1450	80	0,55	1,7	-	2.060	68	20
SINGLE PHASE 6 POLE								
CMPB/6-20-0,18	950	71	0,18	1,6	-	850	51	8
CMPB/6-23-0,18	950	71	0,18	1,6	-	1.660	55	13
CMPB/6-24-0,18	950	71	0,18	1,6	-	1.630	52	13
CMPB/6-25-0,18	950	71	0,18	1,6	-	1.810	51	13
CMPB/6-30-0,37	950	80	0,37	2,7	-	2.760	60	25
CMPB/6-35-1,1	950	100	1,1	7,2	-	4.780	64	42
CMPB/6-25M-0,18	950	71	0,18	1,6	-	1.200	54	13
THREE PHASE 2 POLE								
CMPT/2-14-0,18	2900	63	0,18	0,97	0,56	730	60	4,5
CMPT/2-20-1,1	2900	80	1,1	4,33	2,5	2.100	72	13
CMPT/2-24-2,2	2900	90	2,2	7,62	4,4	2.900	73	26
CMPT/2-25M-2,2	2900	90	2,2	7,62	4,4	2.780	77	26
CMPT/2-20A-0,55	2900	71	0,55	2,23	1,29	900	68	11
CMPT/2-25A-1,5	2900	90	1,5	5	2,9	1.660	78	17
CMPT/2-30A-3	2900	100	3	10	5,8	3.090	80	34
THREE PHASE 4 POLE								
CMPT/4-14-0,18	1450	63	0,18	1,09	0,63	350	45	4,5
CMPT/4-20-0,18	1450	63	0,18	1,09	0,63	1.220	60	8
CMPT/4-23-0,55	1450	80	0,55	2,42	1,4	2.560	64	15
CMPT/4-24-0,55	1450	80	0,55	2,42	1,4	2.400	61	15
CMPT/4-25-0,55	1450	80	0,55	2,42	1,4	2.680	60	15
CMPT/4-30-1,1	1450	90	1,1	4,16	2,4	4.240	69	29
CMPT/4-35-3	1450	100	3	10,91	6,3	6.470	72	48
CMPT/4-42-5,5	1450	132	5,5	-	11,1	7.500	75	88
CMPT/4-42-7,5	1450	132	7,5	-	14,8	11.220	80	102
CMPT/4-25M-0,55	1450	80	0,55	2,42	1,4	1.700	63	15
CMPT/4-20A-0,18	1450	63	0,18	1,09	0,63	530	54	9
CMPT/4-25A-0,25	1450	71	0,25	1,28	0,74	1.100	66	10
CMPT/4-30A-0,55	1450	80	0,55	2,42	1,4	2.060	68	20
CMPT/4-50 50/135-7,5	1465	132	7,5	-	14,2	11.200	-	130
CMPT/4-50 50/135-11	1460	160	11	-	21,1	15.000	-	170
CMPT/4-50 55/145-11	1460	160	11	-	21,1	13.600	-	170
CMPT/4-50 55/145-15	1465	160	15	-	28,6	17.000	-	190

\* Sound pressure dB(A), measured in free field conditions at a distance of 1,5 meters, inlet side and medium working point of the performance curve.

\*\* Absorbed power.

TECHNICAL CHARACTERISTICS CMPB / CMPT

Model	Speed (rpm)	Motor size (mm)	Nominal motor power (kW)	Nominal current (A)		Maximum airflow (m³/h)	Sound pressure level* (dB(A))	Weight (kg)
				230 V	400 V			
THREE PHASE 6 POLE								
CMPT/6-20-0,18	950	71	0,18	1,06	0,61	850	51	8
CMPT/6-23-0,18	950	71	0,18	1,06	0,61	1.660	55	13
CMPT/6-24-0,18	950	71	0,18	1,06	0,61	1.630	52	13
CMPT/6-25-0,18	950	71	0,18	1,06	0,61	1.810	51	13
CMPT/6-30-0,37	950	80	0,37	1,85	1,07	2.760	60	25
CMPT/6-35-1,1	950	90	1,1	5,2	3	4.780	64	42
CMPT/6-42-3	930	132	3	12,64	7,3	8.330	71	88
CMPT/6-25M-0,18	950	71	0,18	1,06	0,61	1.200	54	13
CMPT/6-50 50/135-2,2	940	112	2,2	-	5,36	7.400	-	105
CMPT/6-50 50/135-3	960	132	3	-	6,82	9.700	-	116
CMPT/6-50 55/145-3	960	132	3	-	6,82	8.600	-	116
CMPT/6-50 55/145-4	960	132	4	-	8,74	11.000	-	125
CMPT/6-50 60/160-4	960	132	4	-	8,74	9.500	-	125
CMPT/6-50 60/160-5,5	960	132	5,5	-	12,2	12.000	-	130
CMPT/6-60 50/135-5,5	960	132	5,5	-	12,2	12.000	-	170
CMPT/6-60 50/135-7,5	965	160	7,5	-	16,4	14.500	-	215
CMPT/6-60 50/135-11	970	160	11	-	23,2	17.200	-	220
CMPT/6-60 55/145-7,5	965	160	7,5	-	16,4	14.000	-	215
CMPT/6-60 55/145-11	970	160	11	-	23,2	18.500	-	220
CMPT/6-60 55/145-15	970	180	15	-	31	19.100	-	250
CMPT/6-60 60/160-7,5	965	160	7,5	-	16,4	14.000	-	215
CMPT/6-60 60/160-11	970	160	11	-	23,2	18.500	-	220
CMPT/6-60 60/160-15	970	180	15	-	31	20.750	-	250
CMPT/6-70 50/135-11	970	160	11	-	23,2	19.000	-	260
CMPT/6-70 50/135-15	970	180	15	-	31	24.000	-	288
CMPT/6-70 50/135-18,5	965	200	18,5	-	36	27.600	-	318
CMPT/6-70 55/145-15	970	180	15	-	31	21.500	-	288
CMPT/6-70 55/145-18,5	965	200	18,5	-	36	25.200	-	318
CMPT/6-70 55/145-22	960	200	22	-	43	28.500	-	330
CMPT/6-70 60/160-18,5	965	200	18,5	-	36	23.400	-	318
CMPT/6-70 60/160-22	960	200	22	-	43	26.500	-	330
CMPT/6-70 60/160-30	965	225	30	-	56	33.500	-	385
THREE PHASE 8 POLE								
CMPT/8-50 50/135-1,1	700	100	1,1	-	3,38	7.300	-	89
CMPT/8-50 55/145-1,5	710	112	1,5	-	4,02	6.800	-	103
CMPT/8-50 55/145-2,2	715	132	2,2	-	5,27	8.200	-	112
CMPT/8-50 60/160-2,2	715	132	2,2	-	5,27	8.000	-	112
CMPT/8-50 60/160-3	710	132	3	-	7,2	8.900	-	125
CMPT/8-60 50/135-3	710	132	3	-	7,2	10.500	-	165
CMPT/8-60 50/135-4	720	160	4	-	10,9	13.300	-	194
CMPT/8-60 55/145-4	720	160	4	-	10,9	12.000	-	194
CMPT/8-60 55/145-5,5	710	160	5,5	-	13,4	14.500	-	200
CMPT/8-60 60/160-4	720	160	4	-	10,9	12.200	-	194
CMPT/8-60 60/160-5,5	710	160	5,5	-	13,4	15.000	-	200
CMPT/8-60 60/160-7,5	715	160	7,5	-	18,1	15.900	-	225
CMPT/8-70 50/135 5,5	710	160	5,5	-	13,4	15.200	-	240
CMPT/8-70 50/135 7,5	715	160	7,5	-	18,1	19.900	-	265
CMPT/8-70 50/135 11	720	180	11	-	26,4	20.500	-	290
CMPT/8-70 50/135 11	720	180	11	-	26,4	20.500	-	290
CMPT/8-70 55/145 5,5	710	160	5,5	-	13,4	14.100	-	240
CMPT/8-70 55/145 11	720	180	11	-	26,4	22.200	-	290
CMPT/8-70 60/160 7,5	715	160	7,5	-	18,1	16.200	-	253
CMPT/8-70 60/160 11	720	180	11	-	26,4	22.500	-	290
CMPT/8-70 60/160 15	740	200	15	-	29	25.200	-	310

\* Sound pressure dB(A), measured in free field conditions at a distance of 1,5 meters, inlet side and medium working point of the performance curve.

TECHNICAL CHARACTERISTICS MODELS TMPB/TMPT

Model	Speed (rpm)	Motor size (mm)	Nominal motor power (kW)	Nominal current (A)		Maximum airflow (m³/h)	Sound pressure level* (dB(A))	Weight (kg)
				230 V	400 V			
SINGLE PHASE 2 POLE								
TMPB/2-14-0,18	2900	63	0,18	1,53	–	730	60	4,5
TMPB/2-20-1,1	2900	80	1,1	7,9	–	2.100	72	13
TMPB/2-20A-0,55	2900	71	0,55	4,21	–	900	68	11
SINGLE PHASE 4 POLE								
TMPB/4-14-0,18	1450	63	0,18	1,74	–	350	45	4,5
TMPB/4-20-0,18	1450	63	0,18	1,74	–	1.220	60	8
TMPB/4-24-0,55	1450	80	0,55	4,39	–	2.400	61	15
TMPB/4-25-0,55	1450	80	0,55	4,39	–	2.680	60	15
TMPB/4-30-1,1	1450	90	1,1	7,09	–	4.240	69	29
TMPB/4-20A-0,18	1450	63	0,18	1,74	–	530	54	9
TMPB/4-25A-0,25	1450	71	0,25	2,06	–	1.100	66	10
SINGLE PHASE 6 POLE								
TMPB/6-20-0,18	950	71	0,18	1,6	–	850	51	8
TMPB/6-24-0,18	950	71	0,18	1,6	–	1.630	52	13
TMPB/6-25-0,18	950	71	0,18	1,6	–	1.810	51	13
TMPB/6-30-0,37	950	80	0,37	2,7	–	2.760	60	25
THREE PHASE 2 POLE								
TMPT/2-14-0,18	2900	63	0,18	0,97	0,56	730	60	4,5
TMPT/2-20-1,1	2900	80	1,1	4,33	2,5	2.100	72	13
TMPT/2-24-2,2	2900	90	2,2	7,57	4,37	2.900	73	26
TMPT/2-20A-0,55	2900	71	0,55	2,34	1,35	900	68	11
TMPT/2-25A-1,5	2900	90	1,5	5,8	3,35	1.660	78	17
THREE PHASE 4 POLE								
TMPT/4-14-0,18	1450	63	0,18	1,09	0,63	350	45	4,5
TMPT/4-20-0,18	1450	63	0,18	1,09	0,63	1.220	60	8
TMPT/4-24-0,55	1450	80	0,55	2,42	1,4	2.400	61	15
TMPT/4-25-0,55	1450	80	0,55	2,42	1,4	2.680	60	15
TMPT/4-30-1,1	1450	90	1,1	4,49	2,59	4.240	69	29
TMPT/4-20A-0,18	1450	63	0,18	1,09	0,63	530	54	9
TMPT/4-25A-0,25	1450	71	0,25	1,28	0,74	1.100	66	10
THREE PHASE 6 POLE								
TMPT/6-20-0,18	950	71	0,18	1,11	0,64	850	51	8
TMPT/6-24-0,18	950	71	0,18	1,11	0,64	1.630	52	13
TMPT/6-25-0,18	950	71	0,18	1,11	0,64	1.810	51	13
TMPT/6-30-0,37	950	80	0,37	1,8	1,04	2.760	60	25

\* Sound pressure dB(A), measured in free field conditions at a distance of 1,5 meters, inlet side and medium working point of the performance curve.



**ACOUSTIC CHARACTERISTICS**

Sound power at the inlet and outlet at three points of the curve: low pressure (B), medium pressure (M) and high pressure (H).

Model 4-25		63	125	250	500	1.000	2.000	4.000	8.000	LwA											
ASP	B	46	59	65	71	77	71	70	66	80	Model 4-30	B	53	71	73	81	81	78	76	72	86
	M	43	56	63	67	73	67	66	62	76		M	52	66	69	78	78	75	73	69	83
	H	50	57	59	63	69	63	62	57	72		H	54	64	65	76	77	73	71	66	81
DES	B	49	58	65	76	79	76	75	71	83	DES	B	54	65	75	82	82	79	77	72	87
	M	45	54	62	73	76	71	70	66	79		M	53	63	71	79	80	76	74	69	84
	H	48	53	59	69	69	63	63	58	73		H	51	59	68	76	76	73	71	65	81

Model 4-35		63	125	250	500	1.000	2.000	4.000	8.000	LwA											
ASP	M	54	66	70	80	83	80	79	73	87	Model 4-42	M	60	72	79	87	90	88	85	81	94
	H	55	68	70	78	80	77	75	70	84		H	66	71	74	82	84	82	80	75	89
DES	M	57	66	74	81	86	82	80	72	89	DES	M	66	73	82	88	92	89	86	79	96
	H	57	66	74	80	84	78	76	69	87		H	67	71	79	82	85	83	80	72	89

**6 POLE MOTORS**

Model 6-20		63	125	250	500	1.000	2.000	4.000	8.000	LwA											
ASP	B	26	39	48	56	62	63	62	58	68	Model 6-25M	B	30	46	51	60	67	63	59	54	70
	M	21	34	44	51	57	59	56	52	63		M	29	46	51	58	65	62	57	52	68
	H	23	36	46	51	55	56	53	50	61		H	30	47	52	57	63	62	55	50	67
DES	B	29	38	48	59	62	65	62	58	69	DES	B	40	43	54	63	68	65	60	55	71
	M	23	34	45	55	58	61	57	53	65		M	39	43	55	62	65	63	57	52	69
	H	23	32	47	57	56	59	54	51	63		H	39	45	55	61	62	61	54	49	67

Model 6-24		63	125	250	500	1.000	2.000	4.000	8.000	LwA											
ASP	B	36	48	55	62	66	60	60	55	69	Model 6-23	B	42	58	62	64	69	65	63	60	73
	M	35	47	53	59	63	56	56	51	66		M	36	50	57	61	66	61	60	56	69
	H	44	47	49	56	60	54	53	48	63		H	35	48	53	56	61	54	54	50	64
DES	B	37	46	56	67	67	63	62	58	72	DES	B	39	51	61	66	70	65	63	59	73
	M	34	44	54	64	65	60	59	54	69		M	34	45	55	63	69	61	60	56	71
	H	44	42	48	60	60	55	54	49	64		H	34	44	52	60	62	56	55	50	66

Model 6-25		63	125	250	500	1.000	2.000	4.000	8.000	LwA											
ASP	B	37	50	56	62	68	62	61	57	71	Model 6-30	B	44	62	64	72	72	69	67	63	77
	M	34	47	54	58	64	58	57	53	67		M	43	57	60	69	69	66	64	60	74
	H	41	48	50	54	60	54	53	48	63		H	45	55	56	67	68	64	62	57	72
DES	B	40	49	56	67	70	67	66	62	74	DES	B	45	56	66	73	73	70	68	63	78
	M	36	45	53	64	67	62	61	57	70		M	44	54	62	70	71	67	65	60	75
	H	39	44	50	60	60	54	54	49	64		H	42	50	59	67	67	64	62	56	72

Model 6-35		63	125	250	500	1.000	2.000	4.000	8.000	LwA											
ASP	B	46	57	63	73	77	75	73	68	81	Model 6-42	B	51	64	72	81	84	82	80	75	88
	M	45	57	61	71	74	71	70	64	78		M	51	63	70	78	81	79	76	72	85
	H	46	59	61	69	71	68	66	61	75		H	57	62	65	73	75	73	71	66	80
DES	B	52	59	67	74	80	76	74	67	83	DES	B	58	66	76	81	86	84	81	75	90
	M	48	57	65	72	77	73	71	63	80		M	57	64	73	79	83	80	77	70	87
	H	48	57	65	71	75	69	67	60	78		H	58	62	70	73	76	74	71	63	80

## PERFORMANCE CURVES

- $q_v$ : Airflow in  $m^3/h$  and  $m^3/s$
- $p_{st}$ : Static pressure in Pa
- P: input power in W
- Sound pressure level in dB(A) at 1,5m, at the fan inlet in free field condition
- Dry air at 20°C and 760 mmHg
- Performance data in accordance with ISO 5801 and AMCA 210-99 Standards

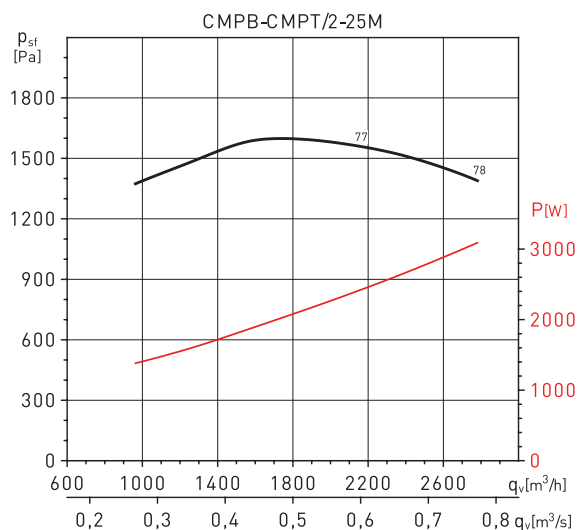
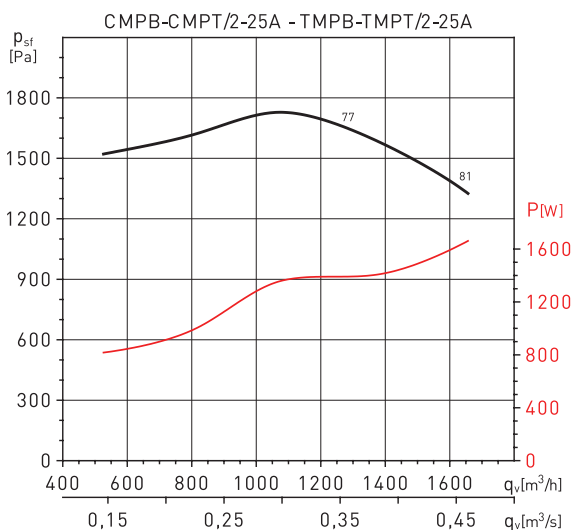
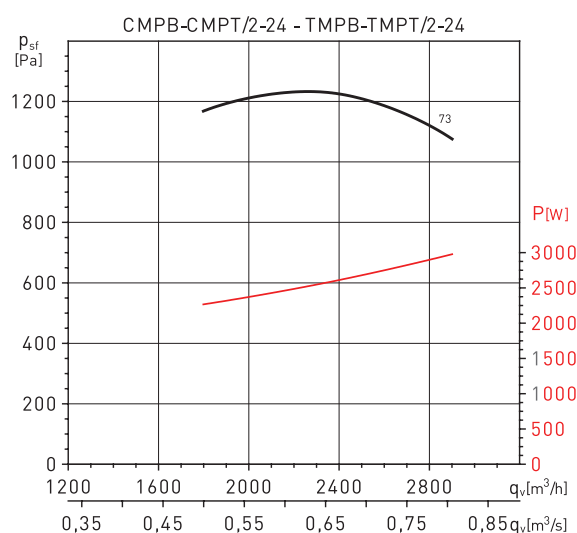
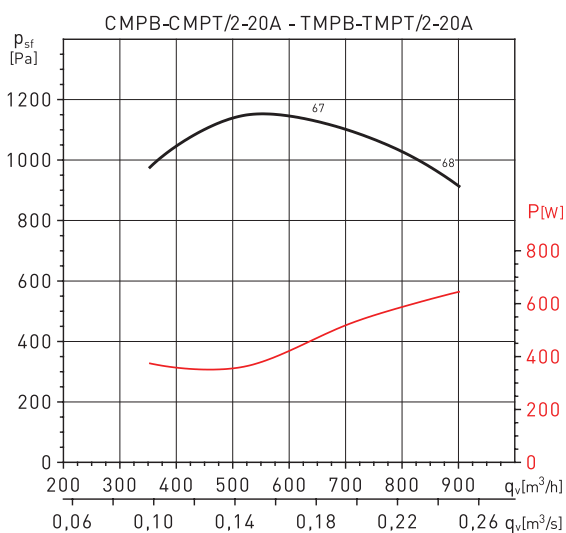
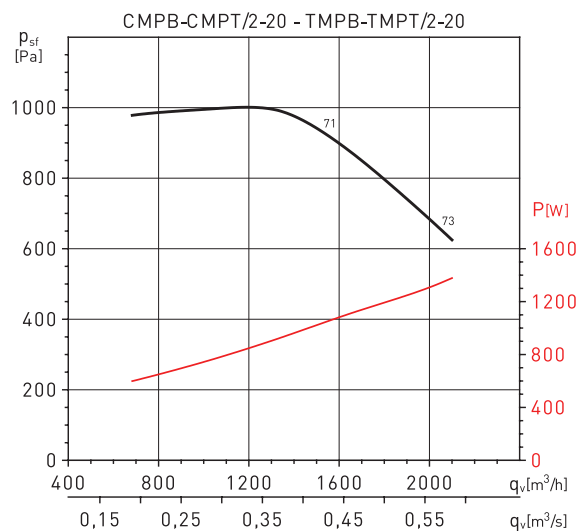
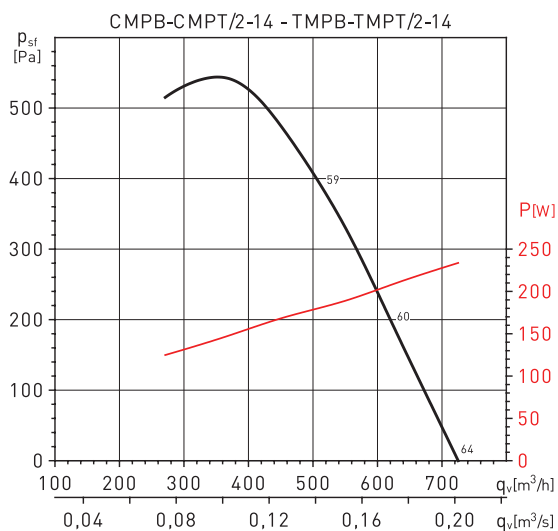



**PERFORMANCE CURVES**

- $q_v$ : Airflow in  $m^3/h$  and  $m^3/s$
- $p_{sf}$ : Static pressure in Pa
- P: input power in W
- Sound pressure level in dB(A) at 1,5m, at the fan inlet in free field condition
- Dry air at 20°C and 760 mmHg
- Performance data in accordance with ISO 5801 and AMCA 210-99 Standards

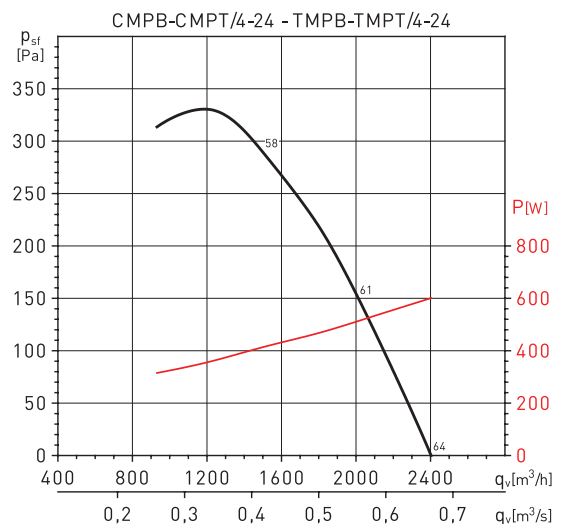
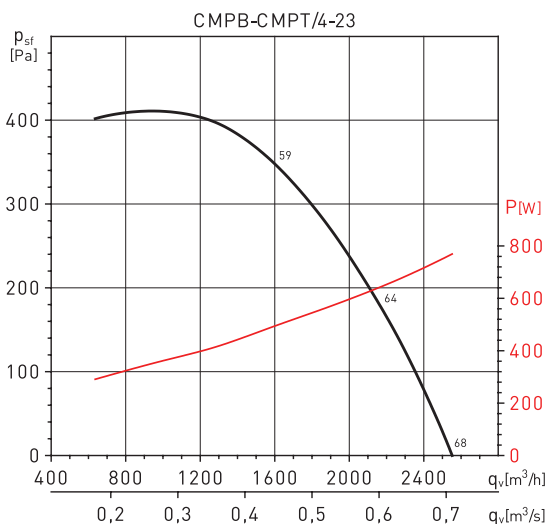
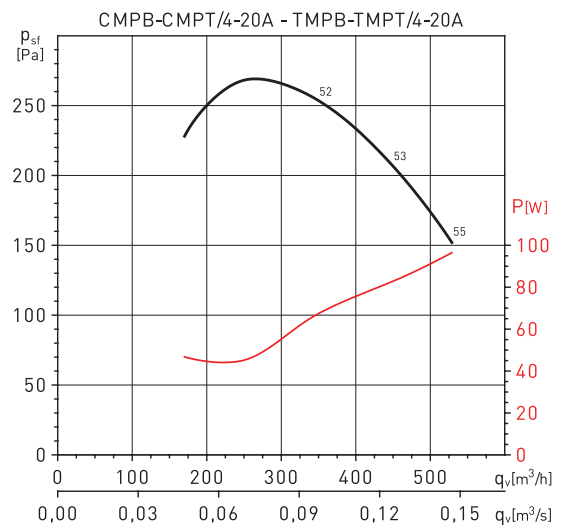
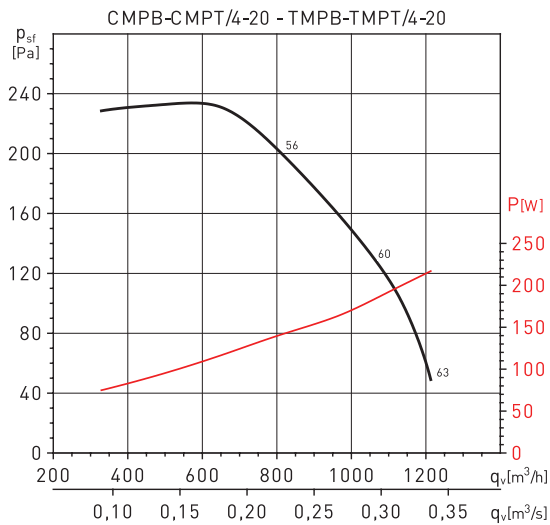
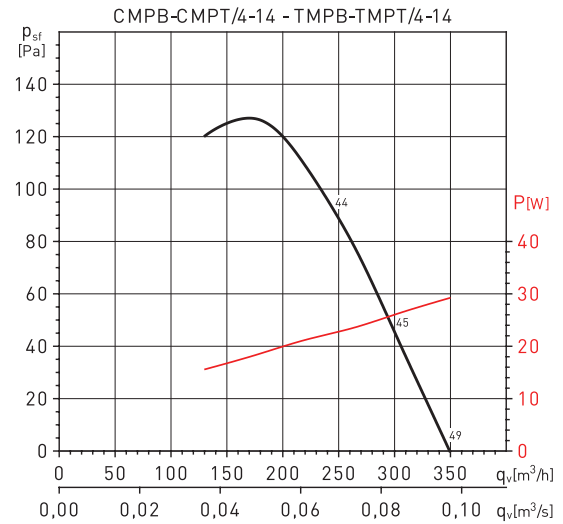
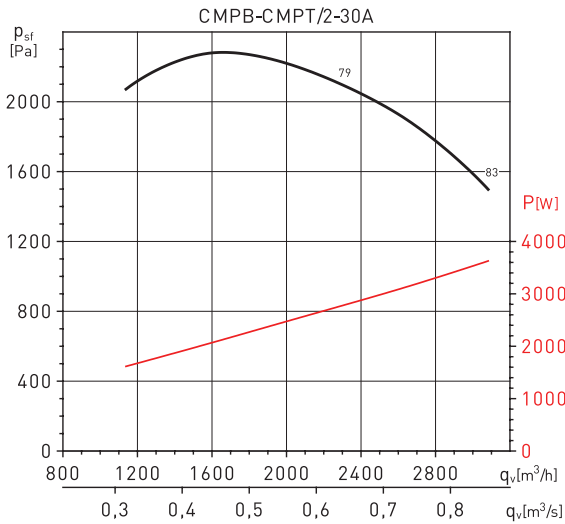

## PERFORMANCE CURVES

- $q_v$ : Airflow in  $m^3/h$  and  $m^3/s$
- $p_{sf}$ : Static pressure in Pa
- P: input power in W
- Sound pressure level in dB(A) at 1,5m, at the fan inlet in free field condition
- Dry air at 20°C and 760 mmHg
- Performance data in accordance with ISO 5801 and AMCA 210-99 Standards

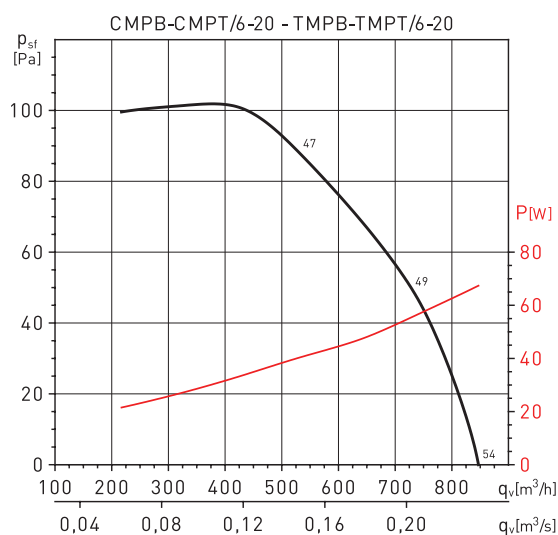
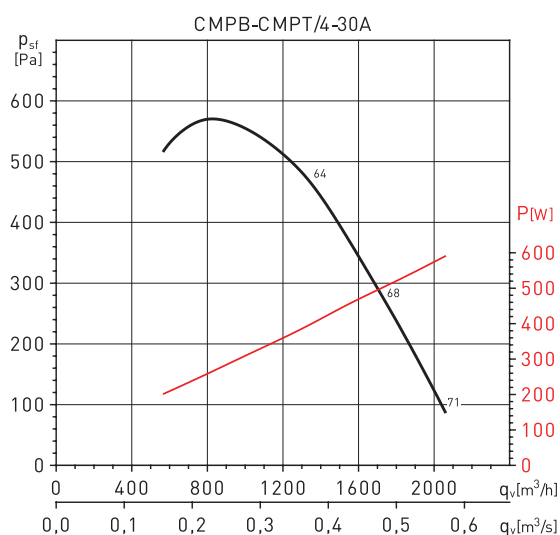
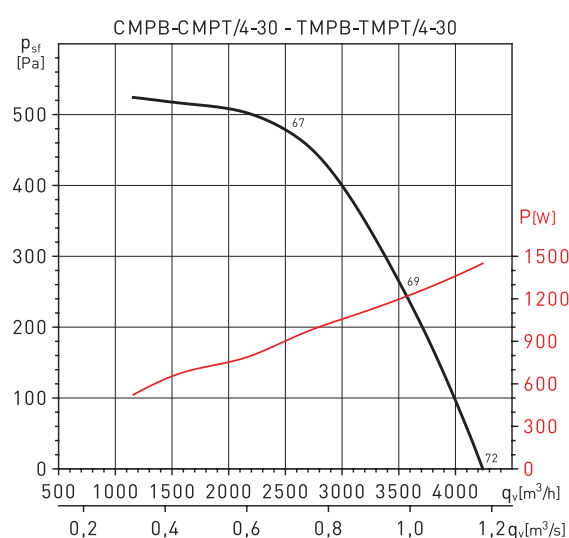
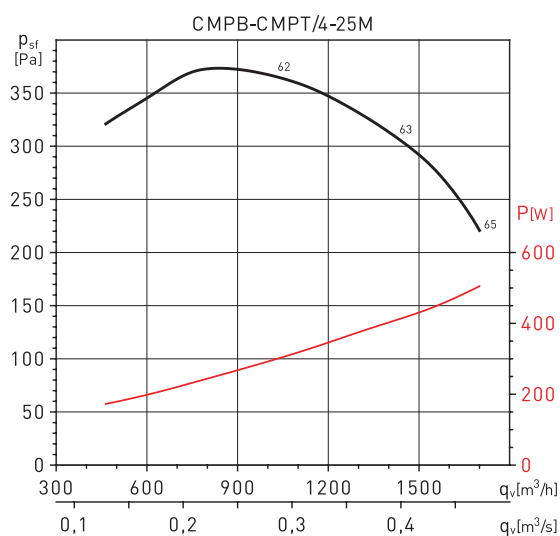
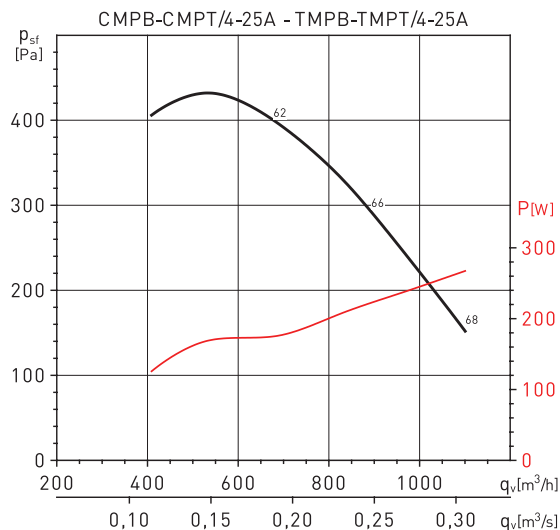
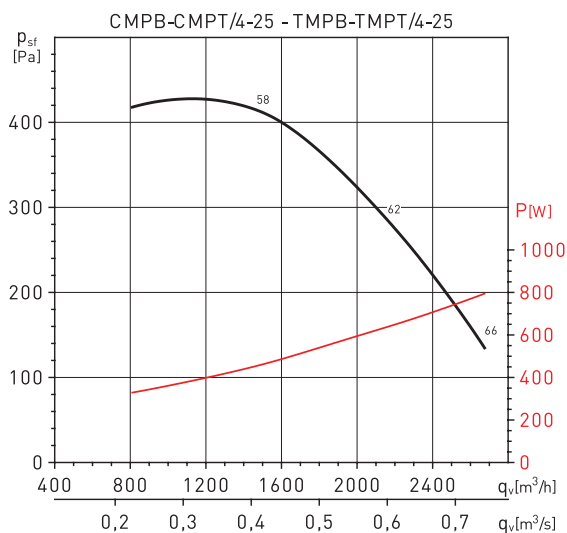

## PERFORMANCE CURVES

- $q_v$ : Airflow in  $m^3/h$  and  $m^3/s$
- $p_{st}$ : Static pressure in Pa
- P: input power in W
- Sound pressure level in dB(A) at 1,5m, at the fan inlet in free field condition
- Dry air at 20°C and 760 mmHg
- Performance data in accordance with ISO 5801 and AMCA 210-99 Standards

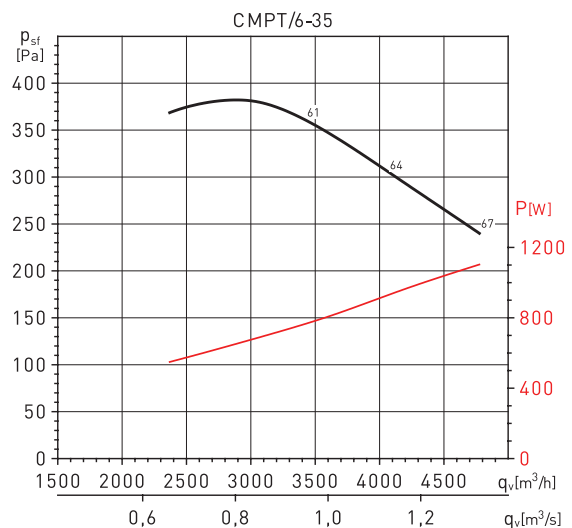
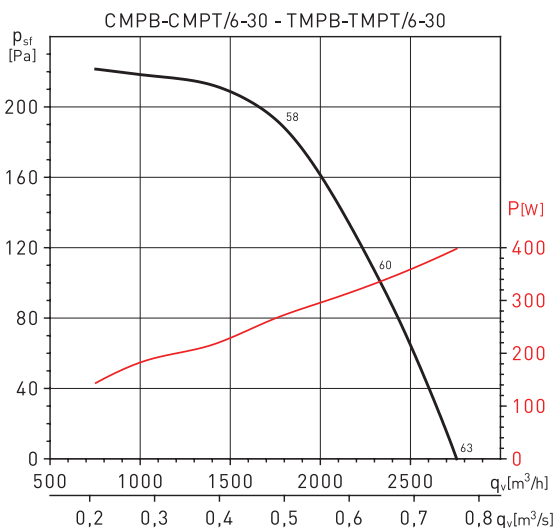
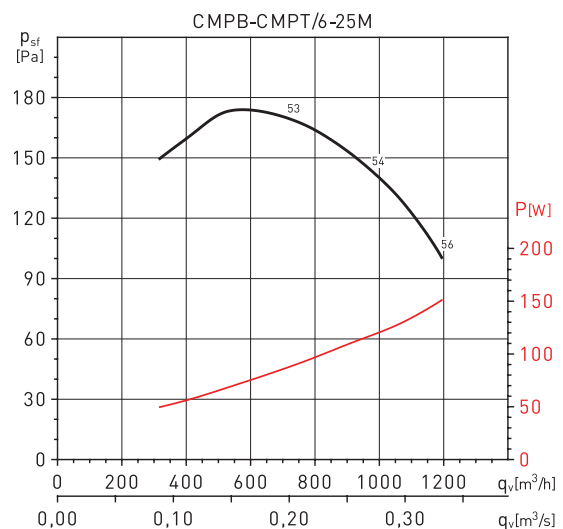
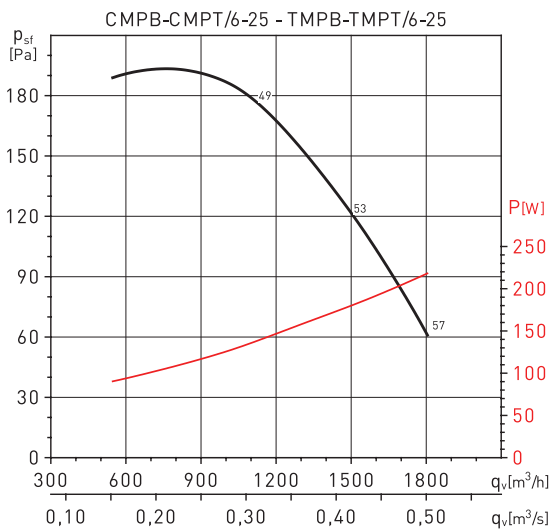
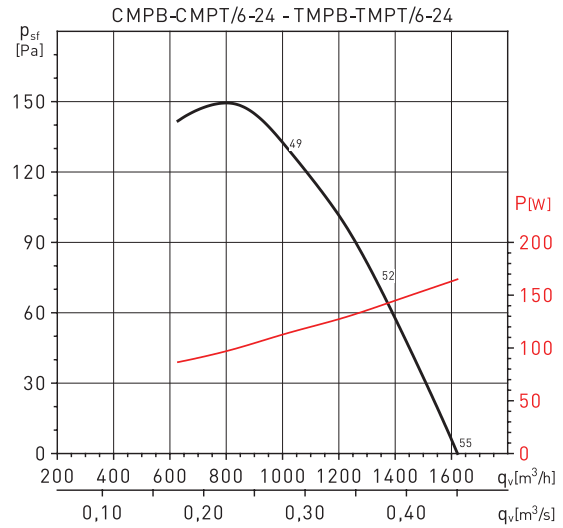
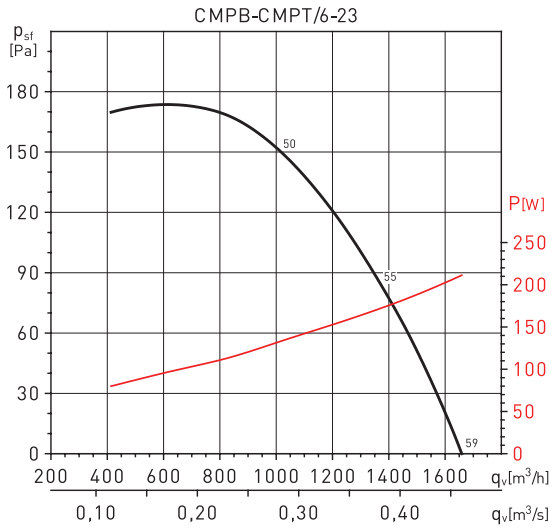

**PERFORMANCE CURVES**

- $q_v$ : Airflow in  $m^3/h$  and  $m^3/s$
- $p_{st}$ : Static pressure in Pa
- P: input power in W
- Sound pressure level in dB(A) at 1,5m, at the fan inlet in free field condition
- Dry air at 20°C and 760 mmHg
- Performance data in accordance with ISO 5801 and AMCA 210-99 Standards

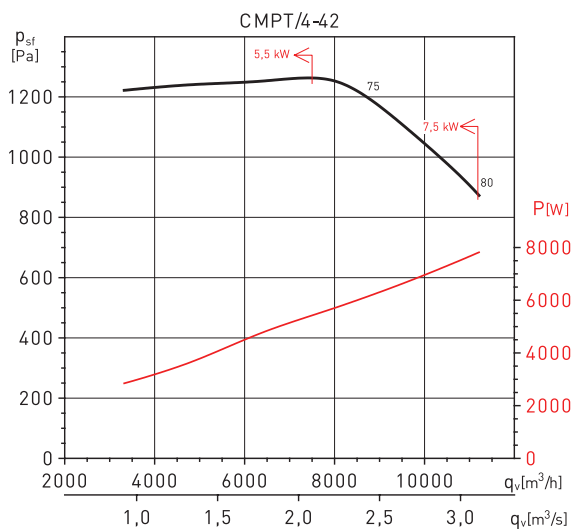
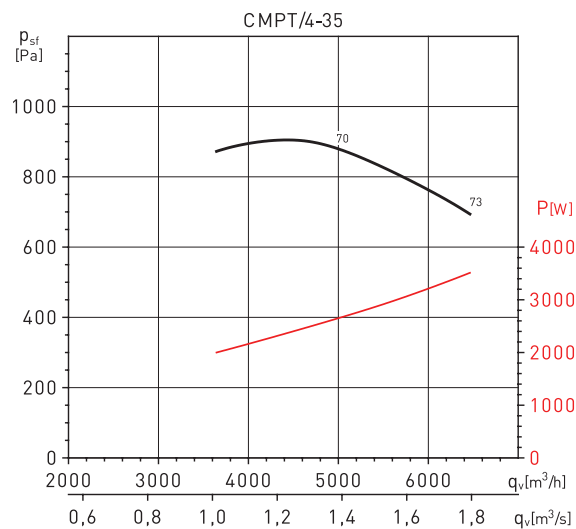
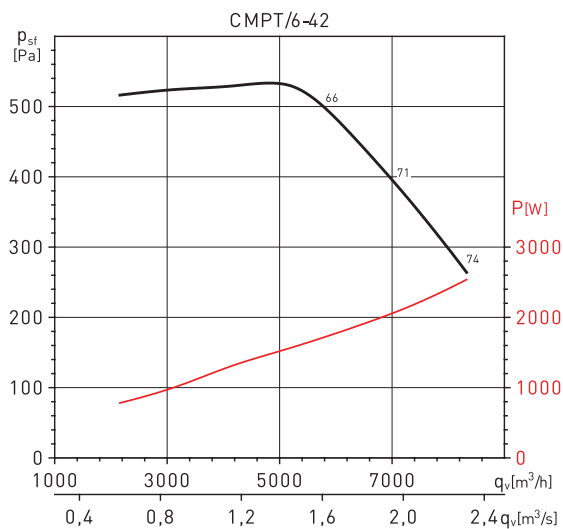

**PERFORMANCE CURVES**

- $q_v$ : Airflow in  $m^3/h$  and  $m^3/s$
- $p_{sf}$ : Static pressure in Pa
- P: input power in W
- Sound pressure level in dB(A) at 1,5m, at the fan inlet in free field condition
- Dry air at 20°C and 760 mmHg
- Performance data in accordance with ISO 5801 and AMCA 210-99 Standards

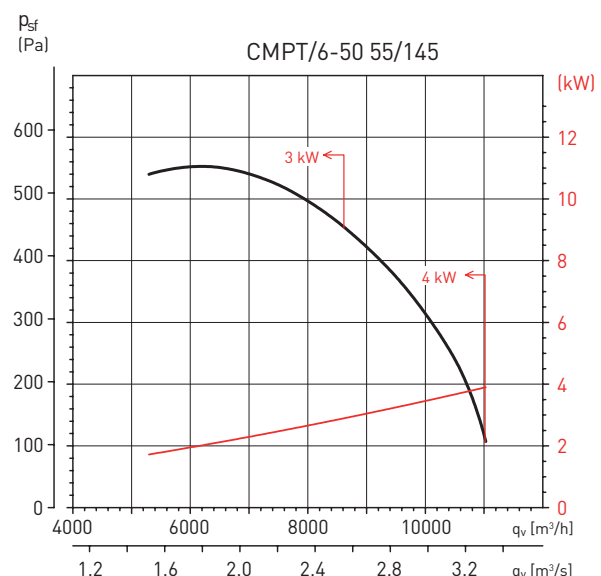
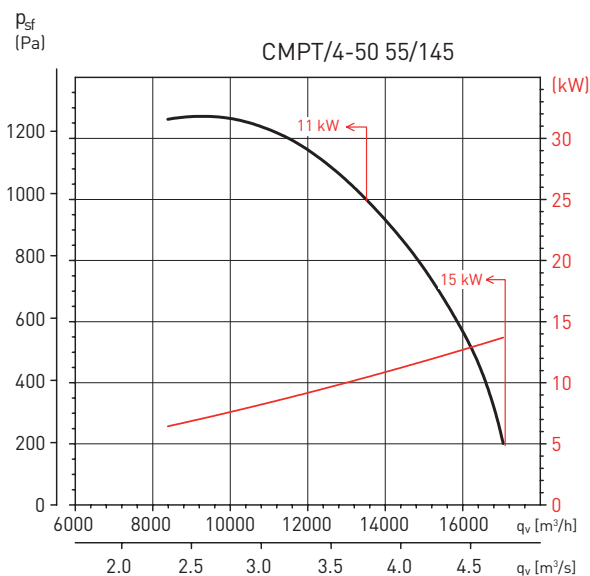
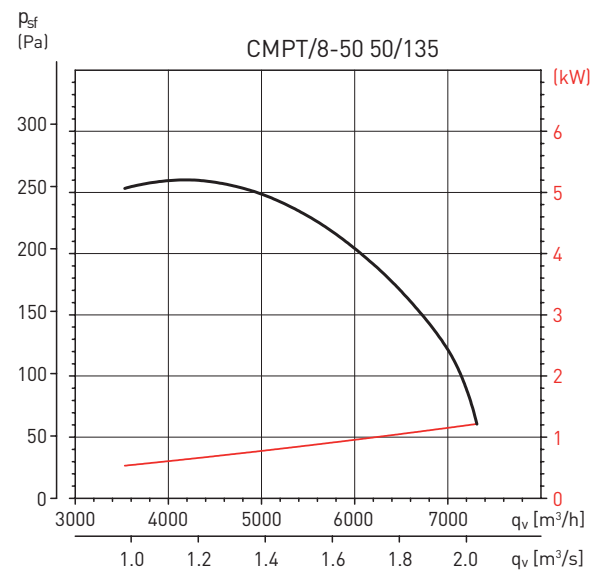
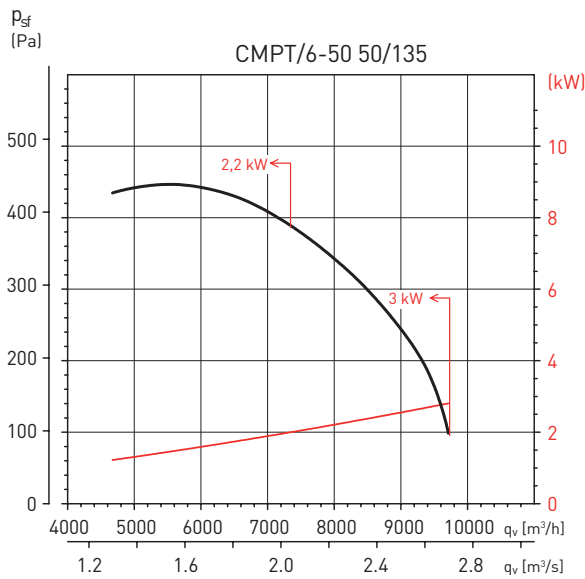
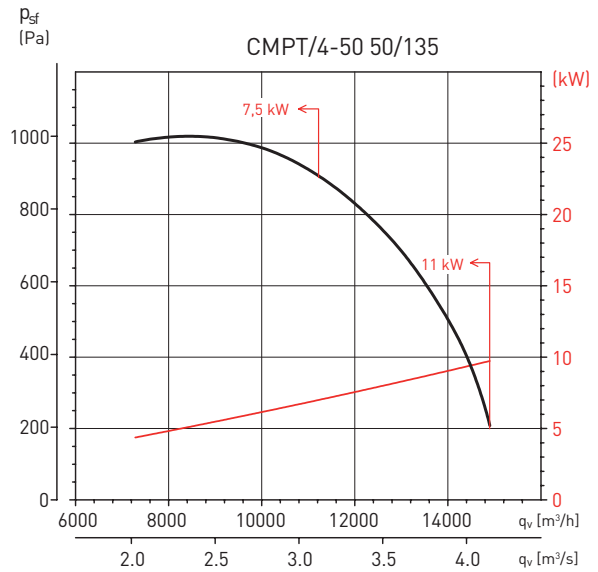

**PERFORMANCE CURVES**

- $q_v$ : Airflow in  $m^3/h$  and  $m^3/s$
- $p_{sf}$ : Static pressure in Pa
- P: input power in W
- Sound pressure level in dB(A) at 1,5m, at the fan inlet in free field condition
- Dry air at 20°C and 760 mmHg
- Performance data in accordance with ISO 5801 and AMCA 210-99 Standards

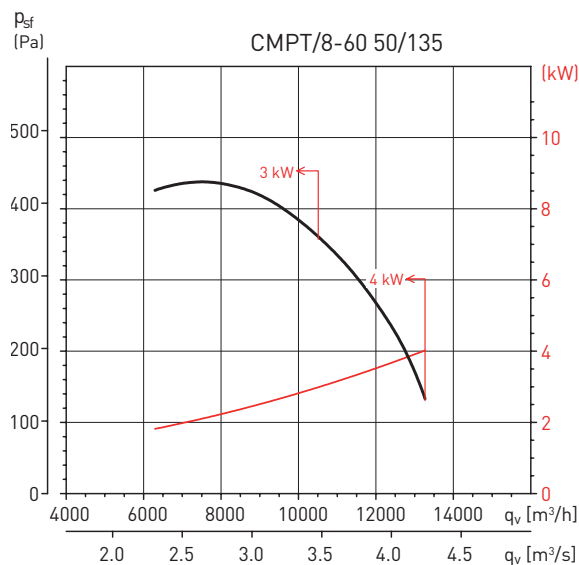
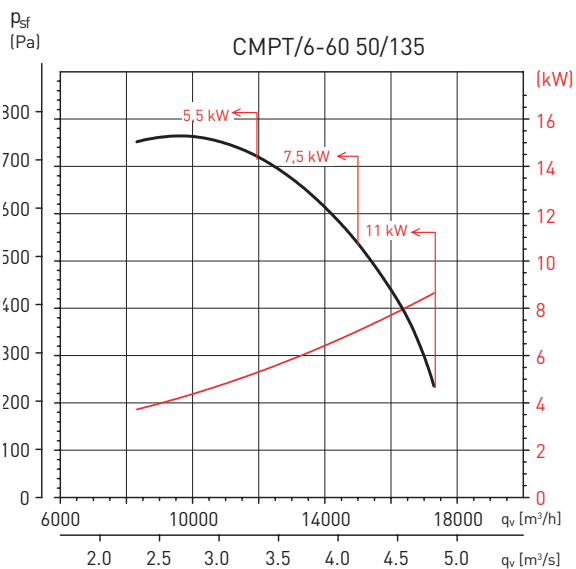
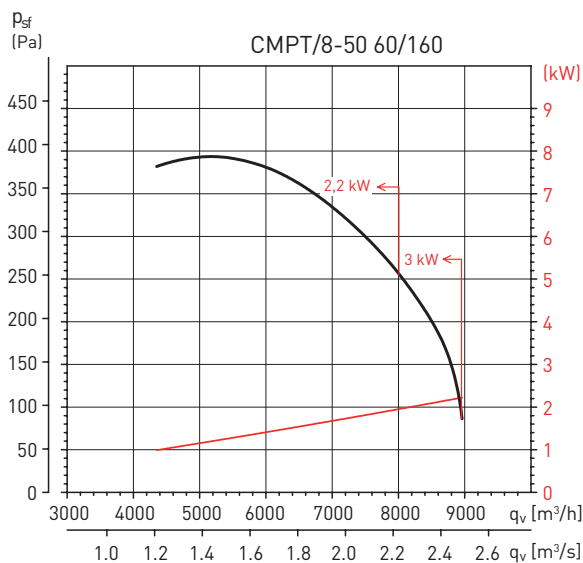
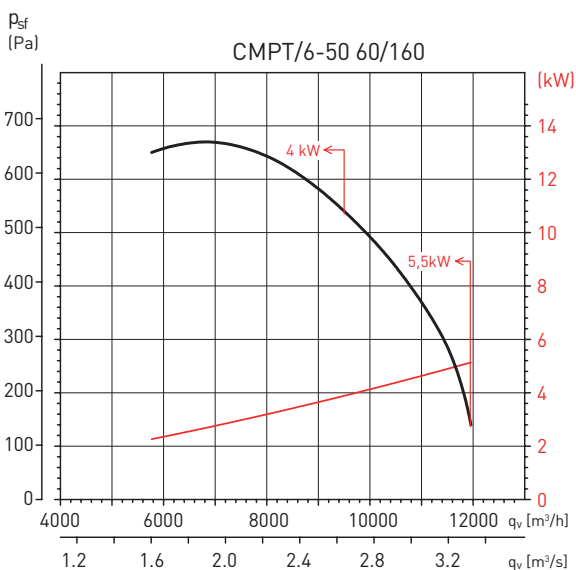
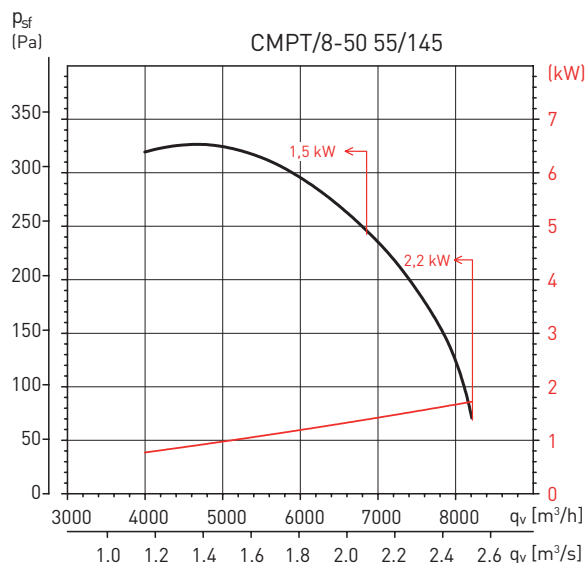

**PERFORMANCE CURVES**

- $q_v$ : Airflow in  $m^3/h$  and  $m^3/s$
- $p_{sf}$ : Static pressure in Pa
- P: input power in W
- Sound pressure level in dB(A) at 1,5m, at the fan inlet in free field condition
- Dry air at 20°C and 760 mmHg
- Performance data in accordance with ISO 5801 and AMCA 210-99 Standards

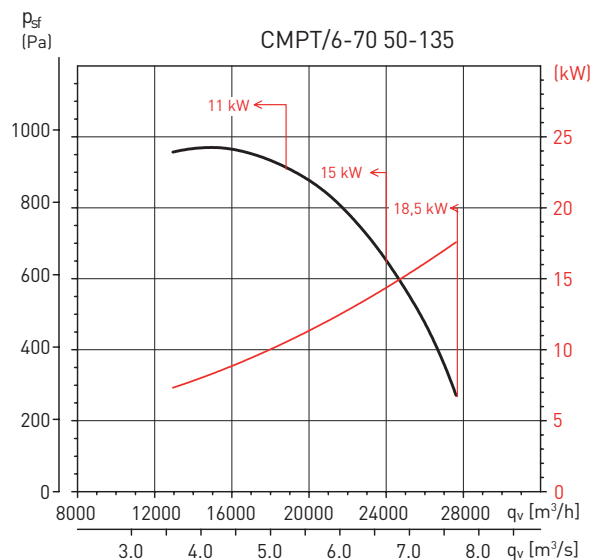
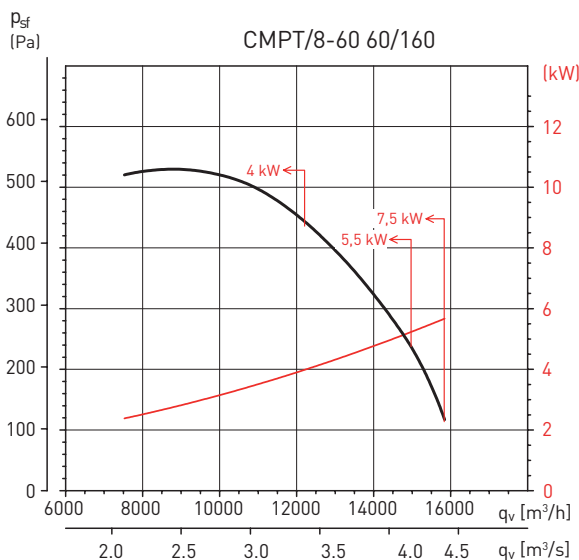
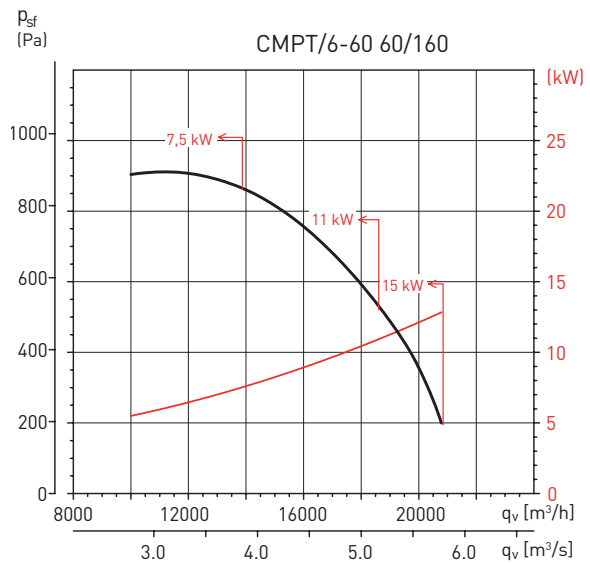
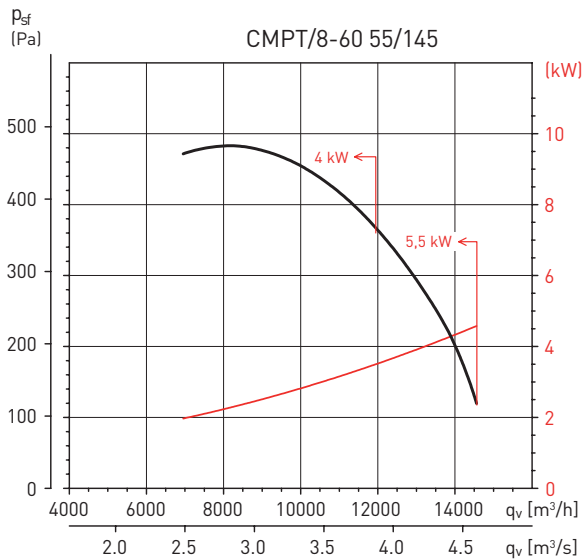
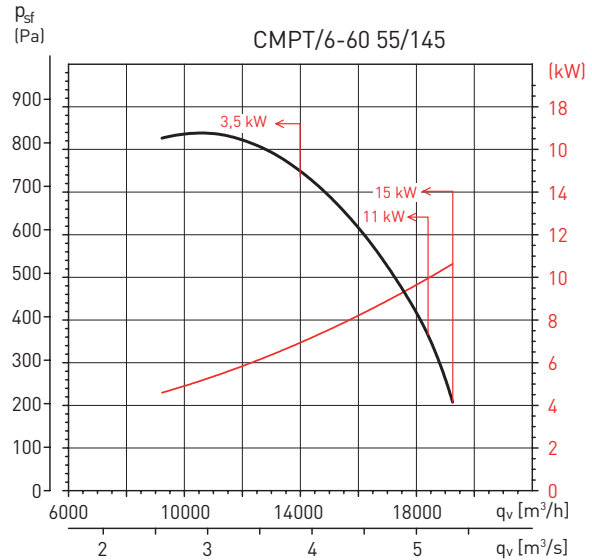

**PERFORMANCE CURVES**

- $q_v$ : Airflow in  $m^3/h$  and  $m^3/s$
- $p_{sf}$ : Static pressure in Pa
- P: input power in W
- Sound pressure level in dB(A) at 1,5m, at the fan inlet in free field condition
- Dry air at 20°C and 760 mmHg
- Performance data in accordance with ISO 5801 and AMCA 210-99 Standards

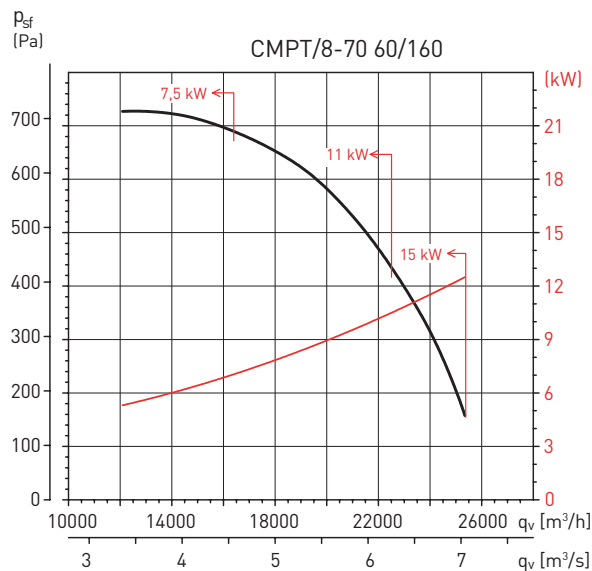
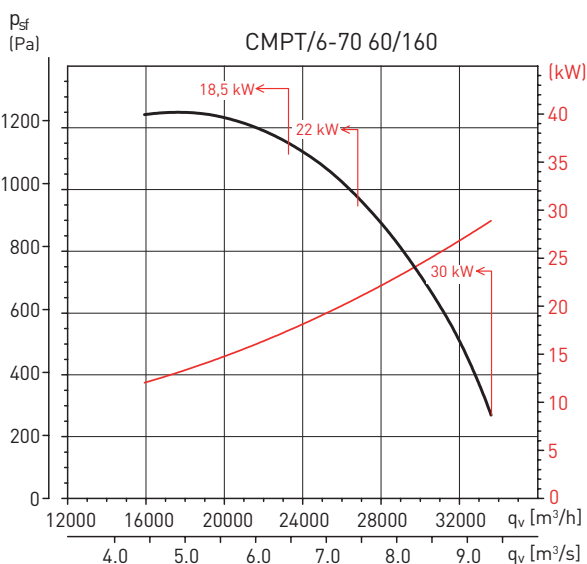
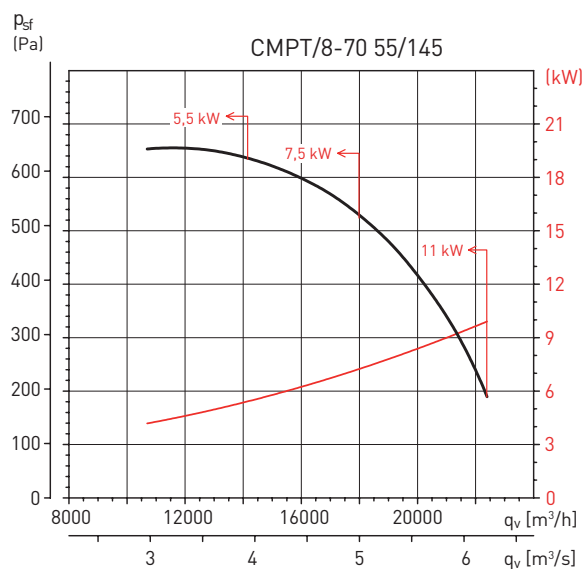
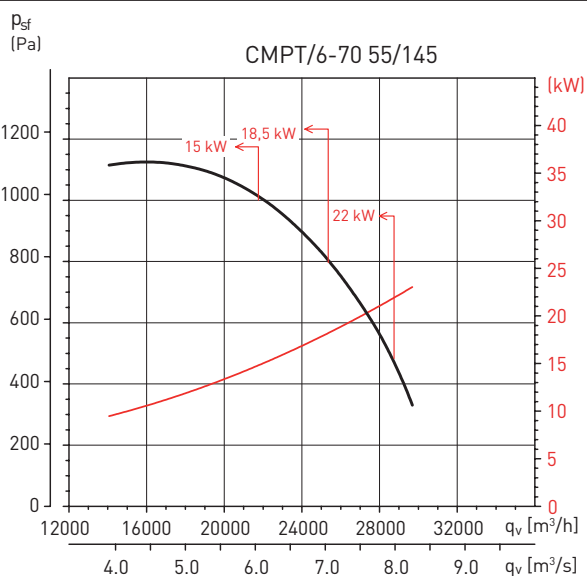
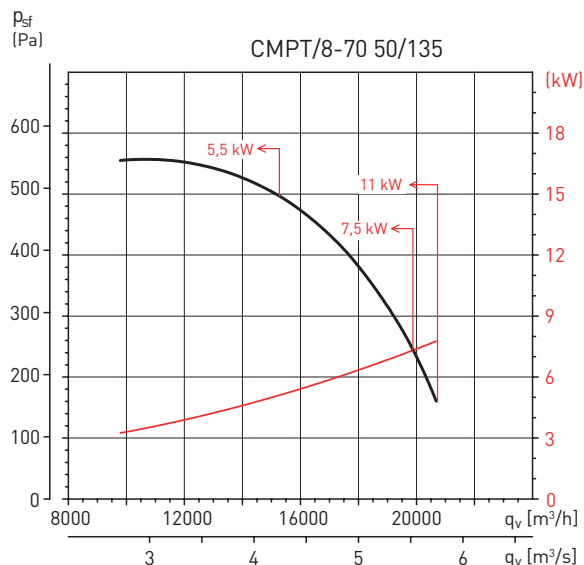



**DIMENSIONS FOR MODELS CMPB-CMPT (mm)**

CMPB-CMPT 14, 20, 23, 24, 25 and 25M

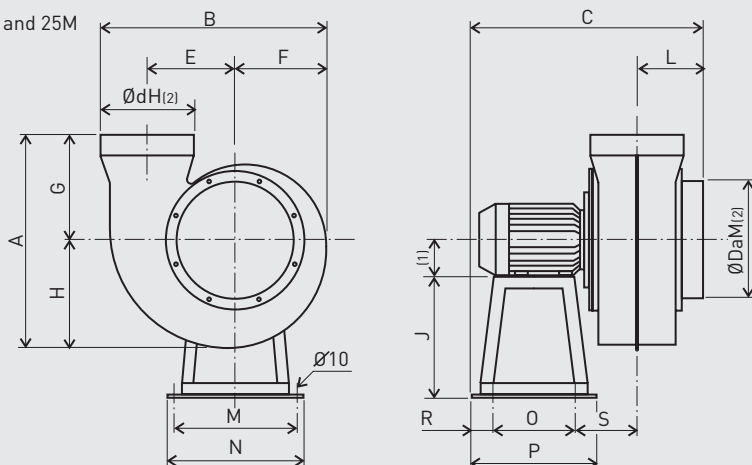

(1) Motor size: for dimensions, see technical characteristics. (2) M: Male flange.

Model	A	B	C	Da	E	F	G	H	J	L	M	N	O	P	R	S	a	b	d
CMPB-CMPT 14	325	284	332	125	103	118	189	136	130	87	175	200	130	200	35	80	-	-	125
CMPB-CMPT 20	501	418	420	200	148	170	300	201	200	120	215	240	170	240	35	95	-	-	200
CMPB-CMPT 23	456	485	505	250	183	202	220	236	250	145	255	280	175	280	53	132	-	-	200
CMPB-CMPT 24	570	520	487	250	185	210	320	250	250	129	255	280	175	280	53	130	-	-	250
CMPB-CMPT 25	570	520	487	250	185	210	320	250	250	129	255	280	175	280	53	130	-	-	250
CMPB-CMPT 25M	456	485	505	250	183	202	220	236	250	145	255	280	175	280	53	132	-	-	200

CMPB-CMPT 30

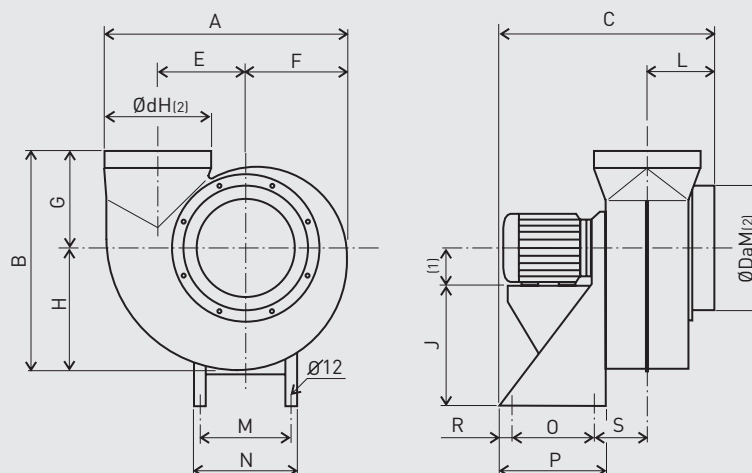

(1) Motor size: for dimensions, see technical characteristics. (2) M: Male flange.

Model	A	B	C	Da	E	F	G	H	J	L	M	N	O	P	R	S	a	b	d
CMPB-CMPT 30	598	545	565	315	222	251	245	300	310	185	234	260	175	275	50	155	-	-	250

**DIMENSIONS FOR MODELS CMPB-CMPT (mm)**

CMPB-CMPT 20A and 25A

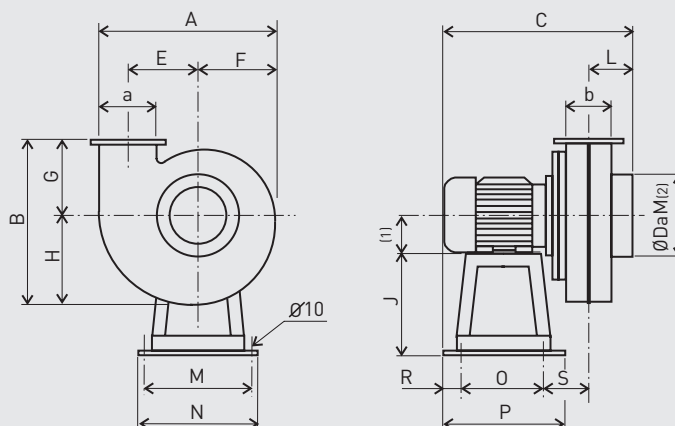

(1) Motor size: for dimensions, see technical characteristics. (2) M:Male flange. (3) This dimension is different in version RD/LG270.

Model	A	B	C	Da	E	F	G	H	J	L	M	N	O	P	R	S	a	b	d
CMPB-CMPT 20A	349	325	370	160	140	157	148	177	200	85	215	240	170	240	35	80	105	90	-
CMPB-CMPT 25A	433	394	444	160	175	193	175	219	250	104	255	280	175	280	53	112	130	115	-

CMPB-CMPT 30a and 35 CMPT 42

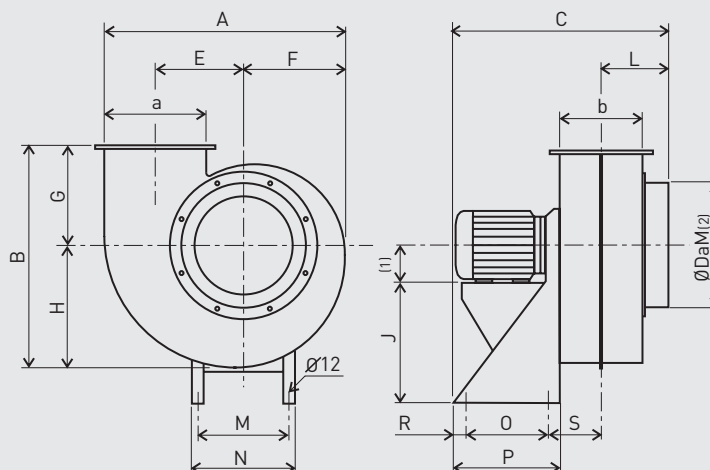

(1) Motor size: for dimensions, see technical characteristics. (2) M:Male flange.

Model	A	B	C	Da	E	F	G	H	J	L	M	N	O	P	R	S	a	b	d
CMPB-CMPT 30A	525	494	510	200	211	237	225	269	310	155	234	260	175	275	50	130	155	140	-
CMPB-CMPT 35	696	626	660	355	259	297	275	353	320	210	285	380	200	300	50	170	280	225	-
CMPT 42	835	724	810	400	310	357	300	424	410	245	315	350	250	350	50	197	335	270	-

**DIMENSIONS FOR MODELS CMPT (mm)**

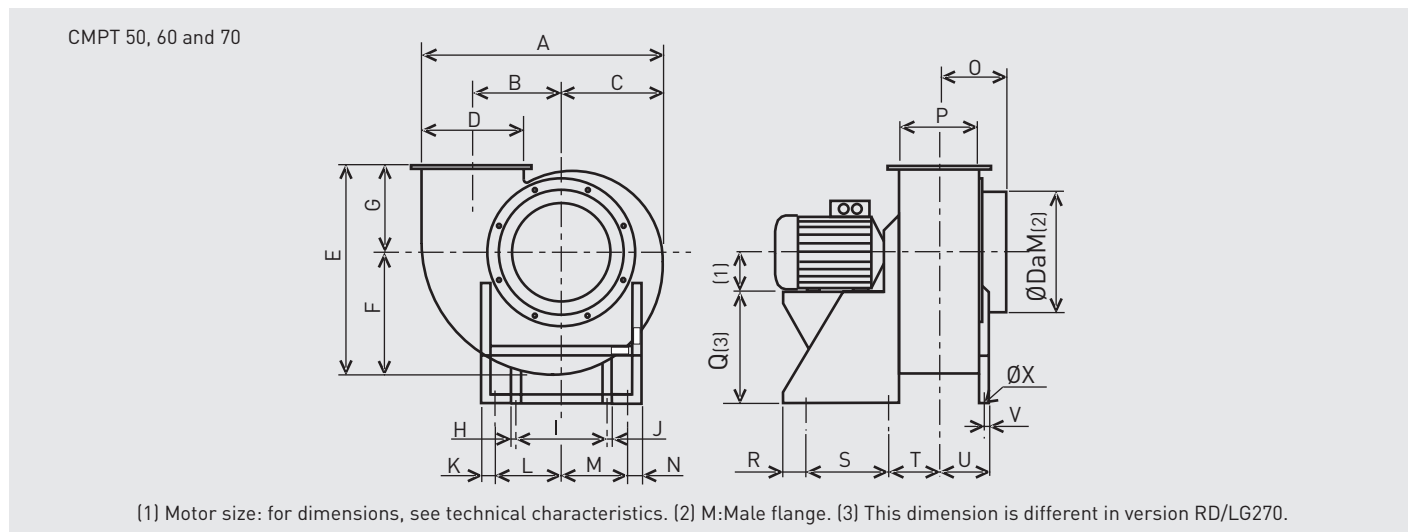

Model	A	B	C	D	E	F	G	H	I	J	K	L	M	N	O	P	Q	R	S	T	U	V	X	Da
CMPT 50	993	370	423	400	861	503	358	20	380	20	60	275	275	60	280	320	470	60	360	231	201	20	14	500
CMPT 60	1191	444	507	480	1029	603	426	25	450	25	60	355	355	60	325	385	540	60	360	270	250	25	14	600
CMPT 70	1387	518	483	560	1193	701	492	25	520	25	70	385	385	70	365	450	700	70	350	310	285	25	14	700

**DIMENSIONS FOR MODELS TMPB/TMPT (mm)**

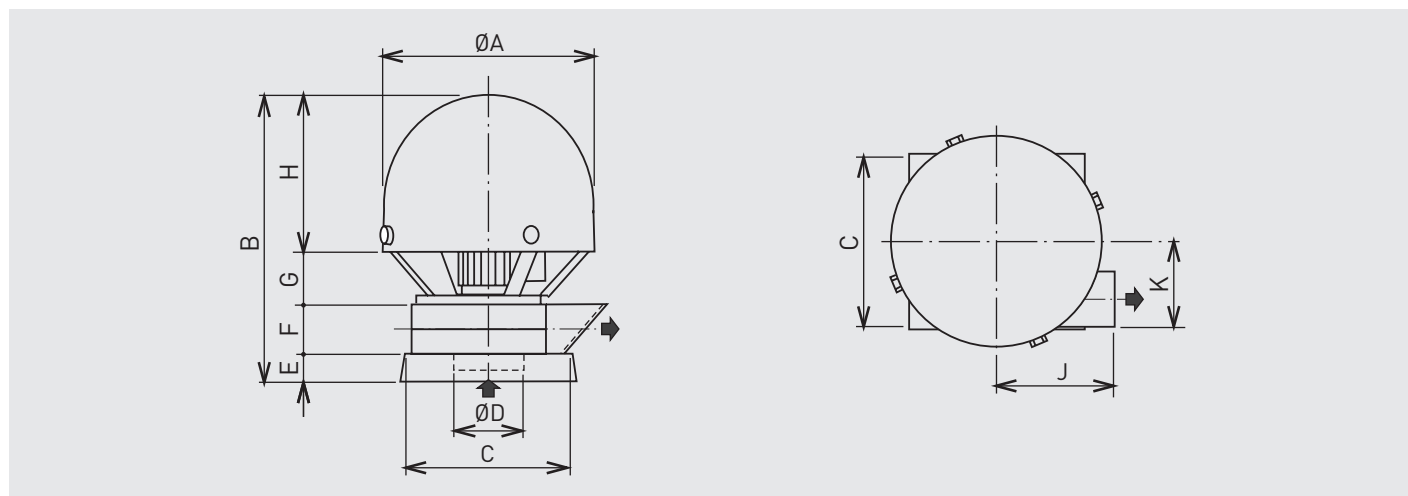

Model	A	B	C*	D	E	F	G	H	J	K
TMPB/TMPT 14	378	512	293	125	50	89	93	280	210	153
TMPB/TMPT 20	385	650	391	200	50	136	104	360	292	235
TMPB/TMPT 24	385	675	491	250	50	166	99	360	351	290
TMPB/TMPT 25	385	675	491	250	50	166	99	360	351	290
TMPB/TMPT 30	385	725	602	315	50	202	113	360	424	347
TMPB/TMPT 20A	385	605	391	160	50	94	104	360	253	200
TMPB/TMPT 25A	385	629	491	160	50	120	99	360	310	247

\* Inside dimension.

## MOUNTING ACCESSORIES CHART - CMPB / CMPT SERIES

Inlet

Model	Inlet diameter Ø	Motor shield	Inlet flexible coupling	Circular damper (inlet)	Inlet silencer	Inlet protection guard
CMPB-CMPT14	125	CMP-14	MFP-125-N	CARP-125-N	SILP-125	DEF.CIR 12
CMPB-CMPT20A	160	CMP-20	MFP-160-N	CARP-160-N	SILP-160	DEF.CIR 16
CMPB-CMPT25A	160	CMP-25	MFP-160-N	CARP-160-N	SILP-160	DEF.CIR 16
CMPB-CMPT30A	200	CMP-30	MFP-200-N	CARP-200-N	SILP-200	DEF.CIR 20
CMPB-CMPT20	200	CMP-20	MFP-200-N	CARP-200-N	SILP-200	DEF.CIR 20
CMPB-CMPT23	250	CMP-25	MFP-250-N	CARP-250-N	SILP-250	DEF.CIR 25
CMPB-CMPT24	250	CMP-25	MFP-250-N	CARP-250-N	SILP-250	DEF.CIR 25
CMPB-CMPT25	250	CMP-25	MFP-250-N	CARP-250-N	SILP-250	DEF.CIR 25
CMPB-CMPT25M	250	CMP-25	MFP-250-N	CARP-250-N	SILP-250	DEF.CIR 25
CMPB-CMPT30	315	CMP-30	MFP-315-N	CARP-315-N	SILP-315	DEF.CIR 30
CMPB-CMPT35	355	CMP-35	MFP-355-N	CARP-355-N	SILP-355	DEF.CIR 35
CMPT42	400	CMP-42	MFP-400-N	CARP-400-N	SILP-400	DEF.CIR 40
CMPT50	500	CMP-50	MFP-500-N	-	SILP-500	DEF.CIR 50
CMPT60	600	CMP-60	MFP-600-N	-	-	DEF.CIR 60
CMPT70	700	CMP-70	MFP-700-N	-	-	DEF.CIR 70



Outlet

Model	Outlet diameter Ø	Connector	Circular discharge protection guard	Rectangular discharge protection guard	Rain sleeve	Circular damper (outlet)	Outlet silencer
CMPT14	125	-	APP-125-N	-	CTP-125-N	CARP-125-N	SILP-125
CMPT20A	105x90*	ACP-20A-N	-	APR-20A	CTP-160-N (+ ACP-20A-N)	CARP-160-N (+ ACP-20A-N)**	SILP-160-N (+ ACP-20A-N)**
CMPT25A	130x115*	ACP-25A-N	-	APR-25A	CTP-160-N (+ACP-25A-N)	CARP-160-N (+ACP-25A-N)**	SILP-160-N (+ACP-25A-N)**
CMPT30A	155x140*	ACP-30A-N	-	APR-30A	CTP-200-N (+ACP-30A-N)	CARP-200-N (+ACP-30A-N)**	SILP-200-N (+ACP-30A-N)**
CMPT20	200	-	APP-200-N	-	CTP-200-N	CARP-200-N	SILP-200
CMPT23	200	-	APP-200-N	-	CTP-200-N	CARP-200-N	SILP-200
CMPT24	250	-	APP-250-N	-	CTP-250-N	CARP-250-N	SILP-250
CMPT25	250	-	APP-250-N	-	CTP-250-N	CARP-250-N	SILP-250
CMPT25M	200	-	APP-200-N	-	CTP-200-N	CARP-200-N	SILP-200
CMPT30	250	-	APP-250-N	-	CTP-250-N	CARP-250-N	SILP-250
CMPT35	280x225*	ACP-35-N	-	APR-35	CTP-400-N (+ REP-400/355 + ACP-35-N)	CARP-400-N (+ REP-400/355 + ACP-35-N)**	SILP-355 (+ ACP-35-N)**
CMPT42	335x270*	ACP-42-N	-	APR-42	CTP-400-N (+ ACP-42-N)	CARP-400-N (+ ACP-42-N)**	SILP-400 (+ ACP-42-N)**
CMPT50	400x320*	ACP-50-N	-	APR-50	CTP-500-N (+ ACP-50-N)	-	SILP-500 (+ ACP-50-N)**
CMPT60	480x385*	ACP-60-N	-	APR-60	-	-	-
CMPT70	560x450*	ACP-70-N	-	APR-70	-	-	-



\* Rectangular section at the discharge (axb).

\*\* Accessories need the rectangular / circular connection to connect at the discharge of the fan.

**MOUNTING ACCESSORIES CHART - TMPB / TMPT SERIES**

Model	Inlet Ø	Inlet flexible coupling	Inlet silencer	Circular damper (inlet)
TMPT14	125	MFP-125-N	-	CARP-125-N
TMPT20A	160	MFP-160-N	SILP-160	-
TMPT25A	160	MFP-160-N	SILP-160	-
TMPT20	200	MFP-200-N	SILP-200	CARP-200-N
TMPT24	250	MFP-250-N	SILP-250	CARP-250-N
TMPT25	250	MFP-250-N	SILP-250	CARP-250-N
TMPT30	315	MFP-315-N	SILP-315	CARP-315-N

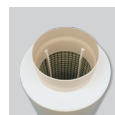

**MOUNTING ACCESSORIES**

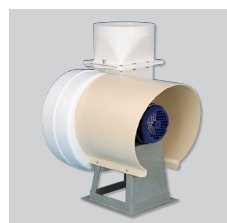

**CMP-14 to 42**



**CMP-50, 60 and 70**

**CMP  
 Motor shield**



**DEF-CIR  
 Protection guard**  
 To prevent any contact with the impeller fan.  
 To install at the inlet side.

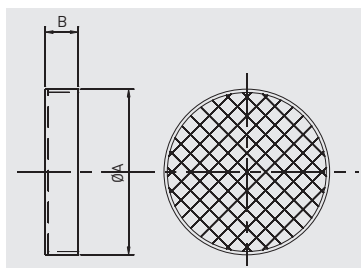

Model	A	B
DEF.CIR 12	125	50
DEF.CIR 16	160	50
DEF.CIR 20	200	50
DEF.CIR 25	250	50
DEF.CIR 30	315	55
DEF.CIR 35	355	80
DEF.CIR 40	400	90
DEF.CIR 50	500	130
DEF.CIR 60	600	130
DEF.CIR 70	700	130

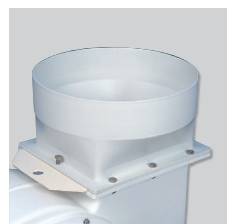

**ACP-N  
 Outlet transformation connector**  
 Provided with a sliding blade to control the airflow.

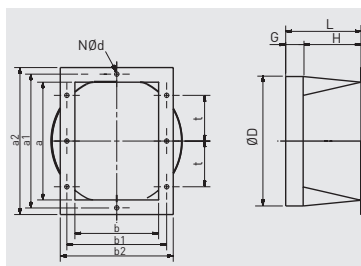

Model	a	b	a1	b1	a2	b2	t	N	d	D	G	H	L
ACP-20A-N	105	90	130	120	150	140	90	6	9	160	40	80	120
ACP-25A-N	130	115	160	160	180	180	80	8	7	160	50	70	120
ACP-30A-N	155	140	200	186	221	210	100/93	8	9	200	50	215	265
ACP-35-N	280	225	326	275	356	305	100	12	9	355	60	150	210
ACP-42-N	335	270	381	322	421	362	100	14	9	400	70	160	230
ACP-50-N	400	320	456	386	496	426	100	16	9	500	70	160	230
ACP-60-N	480	385	536	455	586	505	100	16	9	600	70	390	460
ACP-70-N	560	450	616	520	666	570	100	16	11	700	70	390	460

**MOUNTING ACCESSORIES**

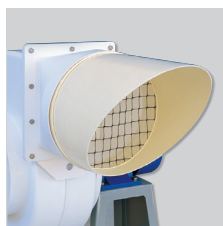

**APP-N**  
**Discharge protection guards**  
 For direct connection to the circular outlet flange.

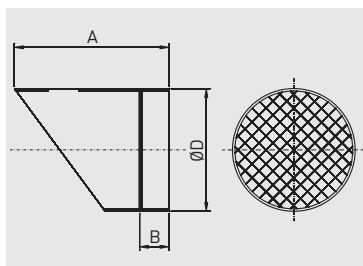

Model	A	B	D
APP-125-N	185	45	125
APP-200-N	280	55	200
APP-250-N	315	60	250

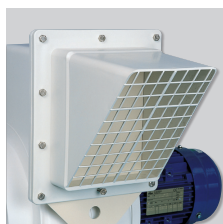

**APR**  
**Protection guard**  
 Protection guards for direct connection to the rectangular outlet flange. Provided with a sliding blade to control the airflow.

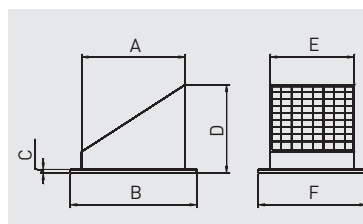

Model	A	B	C	D	E	F
APR-20A	110	150	8	130	100	140
APR-25A	135	180	8	150	120	180
APR-30A	165	221	8	170	135	210
APR-35	292	356	10	249	237	305
APR-42	340	421	8	245	280	362
APR-50	410	496	8	285	330	426
APR-60	490	586	8	330	395	505
APR-70	570	666	8	380	460	570

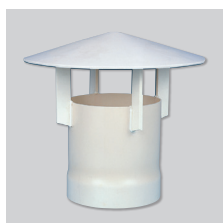

**CTP-N**  
**Rain cowl**  
 Discharge terminal with rain sleeve.

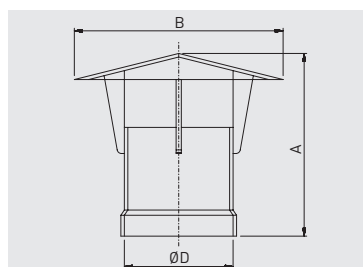

Model	A	B	D
CTP-125-N	300	280	125
CTP-160-N	310	300	160
CTP-200-N	335	400	200
CTP-250-N	420	480	250
CTP-400-N	565	750	400
CTP-500-N	735	980	500



**REP-400/355**  
 PVC reducer used to connect sections of different diameters.

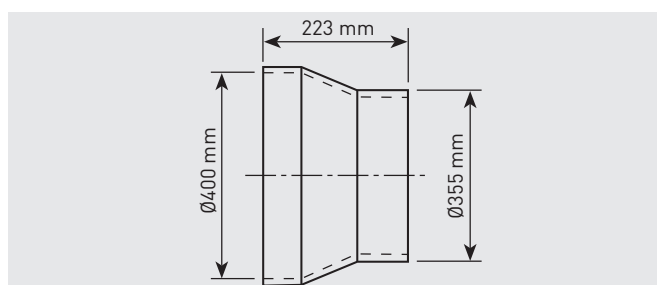

**MOUNTING ACCESSORIES**

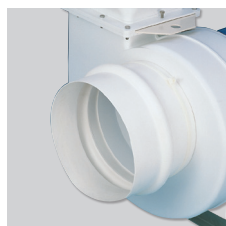

**MFP-N  
Inlet flexible  
connector**  
Fan inlet flexible  
coupling.

Model	Ø (mm)
MFP-125-N	125
MFP-160-N	160
MFP-200-N	200
MFP-250-N	250
MFP-315-N	315

Model	Ø (mm)
MFP-355-N	355
MFP-400-N	400
MFP-500-N	500
MFP-600-N	600
MFP-700-N	700

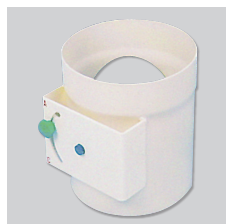

**CARP-N  
Circular damper**  
Manually operated  
circular damper.

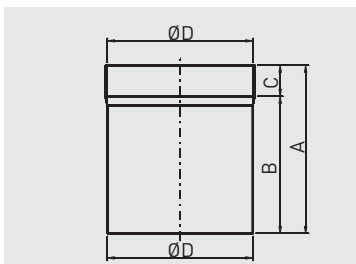

Model	A	B	C	D
CARP-125-N	190	150	40	125
CARP-160-N	240	190	50	160
CARP-200-N	240	190	50	200
CARP-250-N	300	250	50	250
CARP-355-N	400	340	60	355
CARP-400-N	450	390	60	400

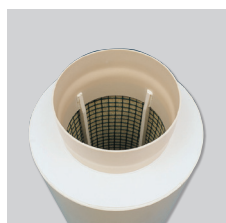

**SILP  
Silencer**  
Silencer to be installed either  
at the inlet or outlet of the fan.

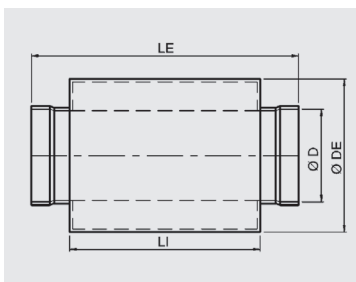

Model	D	DE	LI	LE
SILP-125	125	250	500	700
SILP-160	160	315	500	700
SILP-200	200	355	500	700
SILP-250	250	400	500	700
SILP-315	315	500	750	950
SILP-355	355	600	750	950
SILP-400	400	700	1000	1200
SILP-500	500	800	1000	1200

Model	Attenuation dB(A)							
	63 Hz	125 Hz	250 Hz	500 Hz	1 kHz	2 kHz	4 kHz	8 kHz
SILP-125	-	1	4	8	13	12	7	4
SILP-160	-	1	4	8	13	12	7	4
SILP-200	1	2	5	9	13	12	7	5
SILP-250	3	2	6	10	13	12	8	6
SILP-315	2	3	7	10	13	12	9	9
SILP-355	2	3	8	11	14	11	7	8
SILP-400	3	3	8	11	14	11	7	7
SILP-500	2	4	9	12	18	13	7	7