

EXTRACTION (type B)

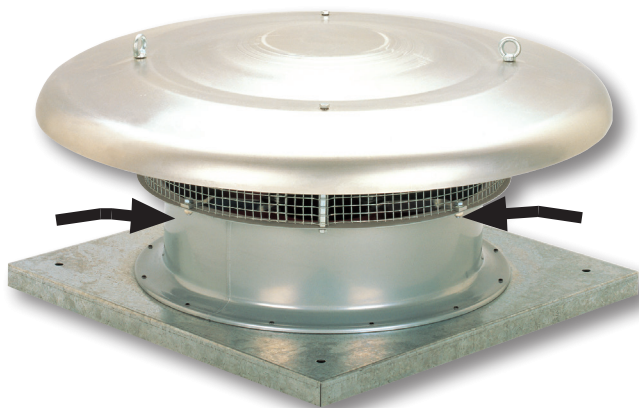

SUPPLY (type A)

Range of axial roof fans with horizontal air discharge configuration available in 2 version:

“B” models for air extract.

“A” models for air supply.

Base manufactured from galvanized sheet steel.

Cowl manufactured from spun aluminium.

The impellers for models 315 to 400 are manufactured from one piece injection moulded plastic, reinforced with chemical anchored fibreglass for additional strength. Models 450 to 1000 incorporate separate plastic blades locked within a die cast aluminium hub.

Available, depending upon the model, with single or three phase motors in 4, 6, 8 or 4/8 poles.

Motors

All motors are IP65 (1) Class F (2) with thermal protection (3) and ball bearings greased for life.

Electrical supply:

Single phase 230V-50Hz (Capacitor located inside the wiring terminal box).

Three phase 400V-50Hz.

(See characteristics chart).

All single phase models are speed controllable by voltage except HCTB/4-560, HCTB/4-630.

All three phase models are speed controllable by autotransformer, except models

HCTT/4-560, HCTT/4-630, Ø 710 to 1000.

Three phase models, 1 speed motor, are speed controllable by inverter.

(1) 800 to 1000 models are IP55.

(2) Air stream temperature limits -40°C to +70°C (except models 800 to 1000 suitable for usage in environments from -30°C to +40°C).

(3) 800 to 1000 models are not equipped with thermal protection.

Specific applications



Versions



Agricultural facilities



Data centers



Swimming pools

Applications

Industrial process ventilation, agricultural facilities, swimming pools and data centers.

HCTT ATEX

ATEX versions available for 3 phase models. For ambient working temperatures from -20°C to +40°C.

Motors IP55, class F.

- ATEX Flameproof - Gas

In standard ATEX version flameproof motors are without thermal protection.

If used with frequency inverter, flameproof motors with a PTC-type thermal protection must be specified at order.

Only available for 800 to 1000 models

⊕ II 2G Ex d IIB T4

⊕ II 2G Ex d IIB+H2 T4 (with motor Ex d IIC T4)

- ATEX Increased safety - Gas

⊕ II 2G Ex e II T3

- ATEX - Dust

In standard ATEX version, ATEX motors for dust are without thermal protection.

If used with frequency inverter, ATEX motors for dust with a PTC-type thermal protection must be specified at order

Only available for 800 to 1000 models

Suspended flammable particles and non-conductive dust:

⊕ II 3D Ex tc IIIB T125°C

Conductive dust:

⊕ II 3D Ex tc IIIC T125°C (with IP65 motor)

To select HXTT ATEX refer to performance data or EASYVENT.

Note electrical data may vary for ATEX motors.



Easy to install

Supports to facilitate installation in the roof.

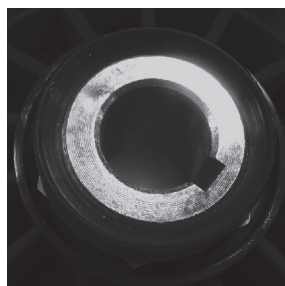

High quality steel sleeve

Ensuring the long life of the fan.

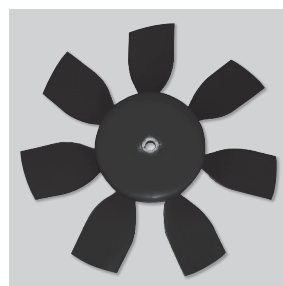

Impeller dynamically balanced

Impellers are dynamically balanced, according to ISO 1940 standard, giving vibration free operation.



Bird-proof guard.

TECHNICAL CHARACTERISTICS – EXTRACT AIR CONFIGURATION

Before installation check that the product electrical characteristics listed on the data plate label (voltage, power, frequency, etc.) match those of the intended electrical supply.

Model	Speed (rpm)	Maximum absorbed power (W)	Maximum absorbed current (A)		Maximum duty (m ³ /h)		Sound pressure level at 1,5 meters* (dB(A))		Weight (kg)	Speed Controller		Variable frequency inverter		Switch for 2-speed motors
			230 V	400 V	High speed	Low*** speed	Inlet	Outlet		REB	RMB/T****	VFTM****	VFKB****	
SINGLE PHASE 4 POLE														
HCTB/4-315-B	1300	100	0,59	-	1.930	-	59	58	14,4	REB-1	RMB-1,5	-	-	-
HCTB/4-355-B	1225	200	0,96	-	2.680	-	56	55	15,8	REB-1	RMB-1,5	-	-	-
HCTB/4-400-B	1290	340	1,64	-	3.700	-	59	58	16,5	REB-2,5	RMB-3,5	-	-	-
HCTB/4-450-B	1290	480	2,30	-	5.600	-	62	61	23,5	REB-2,5	RMB-3,5	-	-	-
HCTB/4-500-B	1290	650	3,00	-	7.100	-	69	67	25,4	REB-5	RMB-3,5	-	-	-
HCTB/4-560-B	1200	980	4,90	-	9.820	-	73	69	40,0	-	-	-	-	-
HCTB/4-630-B	1290	1700	7,60	-	13.000	-	74	70	42,6	-	-	-	-	-
SINGLE PHASE 6 POLE														
HCTB/6-450-B	835	220	1,15	-	3.900	-	53	52	23,5	REB-1	RMB-1,5	-	-	-
HCTB/6-500-B	840	290	1,60	-	4.600	-	56	54	25,4	REB-2,5	RMB-3,5	-	-	-
HCTB/6-560-B	900	420	2,40	-	6.850	-	60	58	40,0	REB-5	RMB-3,5	-	-	-
HCTB/6-630-B	800	510	2,56	-	8.400	-	64	61	42,6	REB-5	RMB-3,5	-	-	-
THREE PHASE 4 POLE														
HCTT/4-315-B	1300	150	-	0,34	1.930	1.500	59	58	14,4	-	RMT-1,5	VFTM TRI-0,37	VFKB-45	-
HCTT/4-355-B	1260	200	-	0,46	2.680	2.000	56	55	15,8	-	RMT-1,5	VFTM TRI-0,37	VFKB-45	-
HCTT/4-400-B	1350	300	-	0,80	3.700	2.900	59	58	16,5	-	RMT-1,5	VFTM TRI-0,37	VFKB-45	-
HCTT/4-450-B	1230	500	-	1,00	5.600	4.500	63	61	23,5	-	RMT-1,5	VFTM TRI-0,37	VFKB-45	-
HCTT/4-500-B	1350	660	-	1,60	7.100	5.850	69	67	25,4	-	RMT-2,5	VFTM TRI-0,55	VFKB-45	-
HCTT/4-560-B	1320	1210	-	2,30	9.820	7.600	73	69	40,0	-	-	VFTM TRI-1,1	VFKB-45	-
HCTT/4-630-B	1290	1600	-	3,20	13.000	-	74	70	42,6	-	-	VFTM TRI-1,5	VFKB-45	-
HCTT/4-710-B	1300	2200	-	4,00	18.400	-	82	80	60,0	-	-	VFTM TRI-1,5	VFKB-45	-
HCTT/4-800-B	1400	3 kW **	-	7,30	23.800	-	89	86	67,0	-	-	VFTM TRI-4	VFKB-48	-
HCTT/4-900-B	1400	4 kW **	-	9,50	30.000	-	92	89	77,0	-	-	VFTM TRI-5,5	-	-
HCTT/4-1000-B	1450	5,5 kW **	-	12,00	38.500	-	93	90	123,0	-	-	VFTM TRI-5,5	-	-
THREE PHASE 4/8 POLE														
HCTT/4/8-400-B	1300/700	250/150	-	0,55/0,35	3.700	1.850	59	58	18,6	-	-	-	-	-
HCTT/4/8-450-B	1360/700	400/170	-	0,80/0,50	5.600	2.800	63	61	26	-	-	-	-	DEMA 0,55/1 DH
HCTT/4/8-500-B	1370/700	550/230	-	1,2/0,8	7.100	3.550	69	67	28	-	-	-	-	DEMA 1/1,3 DH
HCTT/4/8-560-B	1300/700	1100/300	-	2/1	9.820	4.910	73	69	60	-	-	-	-	DEMA 1/2,3 DH
HCTT/4/8-630-B	1400/720	1300/400	-	2,5/1,7	13.000	6.500	74	70	65	-	-	-	-	-
HCTT/4/8-710-B	1300/670	2200/500	-	4,00/1,5	18.400	9.200	82	80	80	-	-	-	-	-
HCTT/4/8-800-B	1430/720	3/0,65 kW **	-	6,8/2,5	23.800	11.900	89	86	85	-	-	-	-	DEMA 3,1/7,6 DH
HCTT/4/8-900-B	1455/730	4/0,75 kW **	-	8,9/3,2	30.000	15.000	92	89	90	-	-	-	-	DEMA 4,2/10 DH
HCTT/4/8-1000-B	1425/715	5,5/1,1 kW **	-	11/3,7	38.500	19.250	93	90	125	-	-	-	-	DEMA 4,2/13 DH
THREE PHASE 6 POLE														
HCTT/6-450-B	835	190	-	0,48	3.900	3.000	53	52	23,5	-	RMT-1,5	VFTM TRI-0,37	VFKB-45	-
HCTT/6-500-B	830	250	-	0,57	4.600	3.500	56	54	25,4	-	RMT-1,5	VFTM TRI-0,37	VFKB-45	-
HCTT/6-560-B	850	410	-	0,93	6.850	5.400	60	58	40,0	-	RMT-1,5	VFTM TRI-0,37	VFKB-45	-
HCTT/6-630-B	810	600	-	1,18	8.400	6.400	64	61	42,6	-	RMT-1,5	VFTM TRI-0,37	VFKB-45	-
HCTT/6-710-B	900	1100	-	3,30	12.700	-	72	70	54,0	-	RMT-5	VFTM TRI-1,5	VFKB-45	-
HCTT/6-800-B	930	0,75 kW **	-	2,50	15.800	-	79	76	57,0	-	-	VFTM TRI-1,1	VFKB-45	-
HCTT/6-900-B	930	1,1 kW **	-	3,50	20.000	-	82	79	67,0	-	-	VFTM TRI-1,5	VFKB-45	-
HCTT/6-1000-B	930	1,5 kW **	-	4,50	24.700	-	83	80	108,0	-	-	VFTM TRI-2,2	VFKB-48	-
THREE PHASE 8 POLE														
HCTT/8-710-B	670	370	-	1,20	9.500	-	64	62	52,0	-	-	VFTM TRI-0,37	VFKB-45	-
HCTT/8-800-B	700	370	-	1,90	11.900	-	71	68	57,0	-	-	VFTM TRI-0,75	VFKB-45	-
HCTT/8-900-B	700	550	-	2,30	15.000	-	74	71	67,0	-	-	VFTM TRI-1,1	VFKB-45	-
HCTT/8-1000-B	700	750	-	2,80	18.600	-	75	72	108,0	-	-	VFTM TRI-1,1	VFKB-45	-

* Sound pressure measured in free field condition. ** Nominal power.

*** Low speed with a delta/star switch.

**** Three phase speed controllers (RMT) or inverter controller (VFKB/VFTM): Three phase 400V.

TECHNICAL CHARACTERISTICS – SUPPLY AIR CONFIGURATION

Before installation check that the product electrical characteristics listed on the data plate label (voltage, power, frequency, etc.) match those of the intended electrical supply.

Model	Speed (rpm)	Maximum absorbed power (W)	Maximum absorbed current (A)		Maximum duty (m³/h)		Sound pressure level at 1,5 meters*		Weight (kg)	Speed Controller		Variable frequency inverter		Switch for 2-speed motors
			230 V	400 V	High speed	Low***	Inlet	Outlet		REB	RMB/T****	VFTM****	VFKB****	
SINGLE PHASE 4 POLE														
HCTB/4-315-A	1300	100	0,54	-	2.150	-	58	64	14,4	REB-1	RMB-1,5	-	-	-
HCTB/4-355-A	1225	200	0,96	-	3.250	-	59	61	15,8	REB-1	RMB-1,5	-	-	-
HCTB/4-400-A	1200	340	1,64	-	4.720	-	64	68	16,5	REB-2,5	RMB-3,5	-	-	-
HCTB/4-450-A	1290	480	2,30	-	6.670	-	68	73	23,5	REB-2,5	RMB-3,5	-	-	-
HCTB/4-500-A	1290	650	3,10	-	8.440	-	72	76	25,4	REB-5	RMB-3,5	-	-	-
HCTB/4-560-A	1250	980	4,90	-	11.400	-	75	80	40,0	-	-	-	-	-
HCTB/4-630-A	1200	1700	7,60	-	15.300	-	79	84	42,6	-	-	-	-	-
SINGLE PHASE 6 POLE														
HCTB/6-450-A	835	220	1,10	-	4.400	-	56	60	23,5	REB-1	RMB-1,5	-	-	-
HCTB/6-500-A	840	290	1,50	-	5.500	-	60	63	25,4	REB-2,5	RMB-1,5	-	-	-
HCTB/6-560-A	900	420	2,30	-	7.900	-	64	68	40,0	REB-2,5	RMB-3,5	-	-	-
HCTB/6-630-A	900	510	2,50	-	9.900	-	66	70	42,6	REB-5	RMB-3,5	-	-	-
THREE PHASE 4 POLE														
HCTT/4-315-A	1360	150	-	0,34	2.150	1.820	58	64	14,4	-	RMT-1,5	VFTM TRI-0,37	VFKB-45	-
HCTT/4-355-A	1350	200	-	0,46	3.250	2.520	59	61	15,8	-	RMT-1,5	VFTM TRI-0,37	VFKB-45	-
HCTT/4-400-A	1380	300	-	0,80	4.720	3.900	64	68	16,5	-	RMT-1,5	VFTM TRI-0,37	VFKB-45	-
HCTT/4-450-A	1350	500	-	0,95	6.670	5.250	68	71	23,5	-	RMT-1,5	VFTM TRI-0,37	VFKB-45	-
HCTT/4-500-A	1380	660	-	1,60	8.440	7.000	72	76	25,4	-	RMT-2,5	VFTM TRI-0,55	VFKB-45	-
HCTT/4-560-A	1380	1210	-	2,30	11.400	9.800	75	80	40,0	-	-	VFTM TRI-1,1	VFKB-45	-
HCTT/4-630-A	1360	1600	-	3,00	15.300	-	79	84	42,6	-	-	VFTM TRI-1,5	VFKB-45	-
HCTT/4-710-A	1300	2200	-	4,00	20.500	-	80	85	60,0	-	-	VFTM TRI-1,5	VFKB-45	-
HCTT/4-800-A	1400	3 kW **	-	7,30	26.600	-	85	90	67,0	-	-	VFTM TRI-4	VFKB-48	-
HCTT/4-900-A	1400	4 kW **	-	9,50	35.900	-	88	94	77,0	-	-	VFTM TRI-5,5	-	-
HCTT/4-1000-A	1400	5,5 kW **	-	12,00	44.900	-	89	95	123,0	-	-	VFTM TRI-5,5	-	-
THREE PHASE 4/8 POLE														
HCTT/4/8-400-A	1300/700	250/150	-	0,55/0,35	4.720	2.360	59	58	18,6	-	-	-	-	-
HCTT/4/8-450-A	1360/700	400/170	-	0,80/0,50	6.670	3.335	63	61	26	-	-	-	-	DEMA 0,55/1 DH
HCTT/4/8-500-A	1370/700	550/230	-	1,2/0,8	8.440	4.220	69	67	28	-	-	-	-	DEMA 1/1,3 DH
HCTT/4/8-560-A	1300/700	1100/300	-	2/1	11.400	5.700	73	69	60	-	-	-	-	DEMA 1/2,3 DH
HCTT/4/8-630-A	1400/720	1300/400	-	2,5/1,7	15.300	7.650	74	70	65	-	-	-	-	-
HCTT/4/8-710-A	1300/670	2200/500	-	4,00/1,5	20.500	10.250	82	80	80	-	-	-	-	-
HCTT/4/8-800-A	1430/720	3/0,65 kW **	-	6,8/2,5	26.600	13.300	89	86	85	-	-	-	-	DEMA 3,1/7,6 DH
HCTT/4/8-900-A	1455/730	4/0,75 kW **	-	8,9/3,2	35.900	17.950	92	89	90	-	-	-	-	DEMA 4,2/10 DH
HCTT/4/8-1000-A	1425/715	5,5/1,1 kW **	-	11/3,7	44.900	22.450	93	90	125	-	-	-	-	DEMA 4,2/13 DH
THREE PHASE 6 POLE														
HCTT/6-450-A	835	190	-	0,48	4.400	3.600	56	60	23,5	-	RMT-1,5	VFTM TRI-0,37	VFKB-45	-
HCTT/6-500-A	830	250	-	0,57	5.500	4.500	60	63	25,4	-	RMT-1,5	VFTM TRI-0,37	VFKB-45	-
HCTT/6-560-A	850	410	-	0,93	7.900	6.700	64	68	40,0	-	RMT-1,5	VFTM TRI-0,37	VFKB-45	-
HCTT/6-630-A	810	600	-	1,18	9.900	7.800	66	70	42,6	-	RMT-1,5	VFTM TRI-0,37	VFKB-45	-
HCTT/6-710-A	900	1100	-	3,30	14.200	-	69	75	54,0	-	-	VFTM TRI-1,5	VFKB-45	-
HCTT/6-800-A	930	0,75 kW**	-	2,50	17.700	-	75	80	57,0	-	-	VFTM TRI-1,1	VFKB-45	-
HCTT/6-900-A	930	1,1 kW**	-	3,50	23.800	-	78	84	67,0	-	-	VFTM TRI-1,5	VFKB-45	-
HCTT/6-1000-A	930	1,5 kW**	-	4,50	28.800	-	79	85	108,0	-	-	VFTM TRI-2,2	VFKB-48	-
THREE PHASE 8 POLE														
HCTT/8-710-A	670	370	-	1,20	10.600	-	61	67	52,0	-	-	VFTM TRI-0,37	VFKB-45	-
HCTT/8-800-A	700	0,37 kW**	-	1,90	13.300	-	67	72	57,0	-	-	VFTM TRI-0,75	VFKB-45	-
HCTT/8-900-A	700	0,55 kW**	-	2,30	18.000	-	70	76	67,0	-	-	VFTM TRI-1,1	VFKB-45	-
HCTT/8-1000-A	700	0,75 kW**	-	2,80	21.700	-	71	77	105,0	-	-	VFTM TRI-1,1	VFKB-45	-

* Sound pressure measured in free field condition. ** Nominal power.

*** Low speed with a delta/star switch.

**** Three phase speed controllers (RMT) or inverter controller (VFKB/VFTM): Three phase 400V.

PERFORMANCE CURVES – EXTRACT AIR CONFIGURATION (TYPE B)

- q_v : Airflow in m^3/h and m^3/s .
- p_{sf} : Static pressure in mmWG and Pa.
- Dry air at 20°C and 760 mmHg.
- Performance data in accordance with ISO 5801 and AMCA 210-99 Standards.

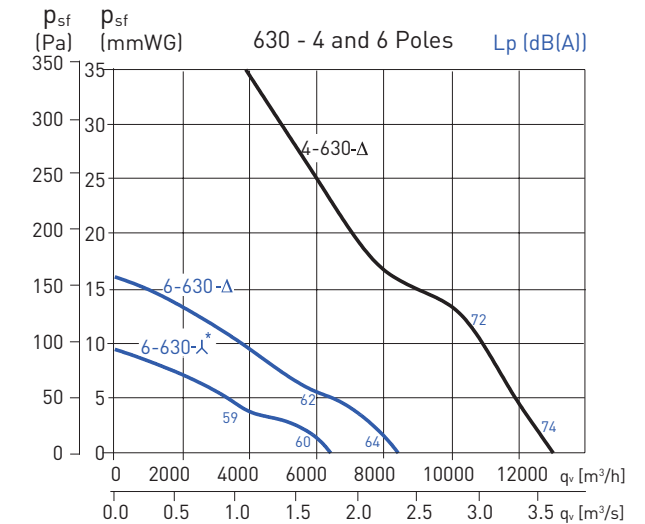
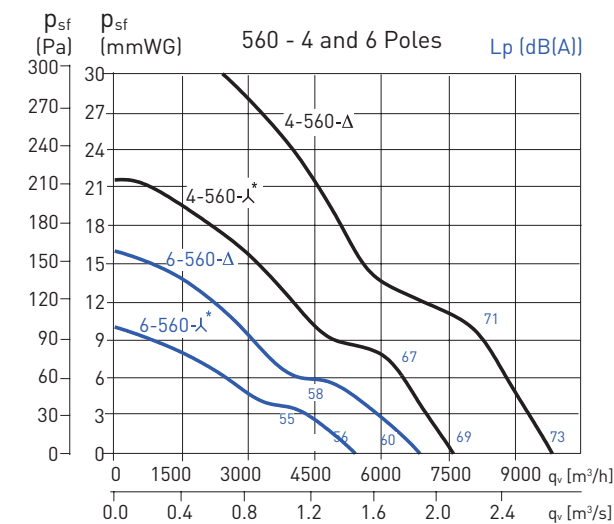
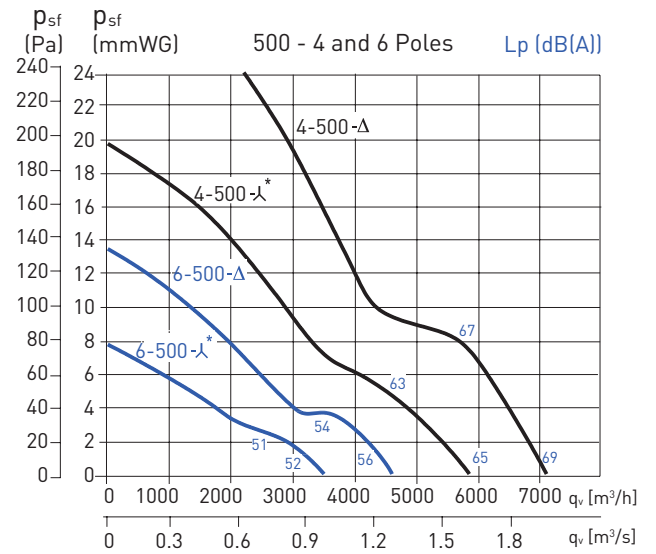
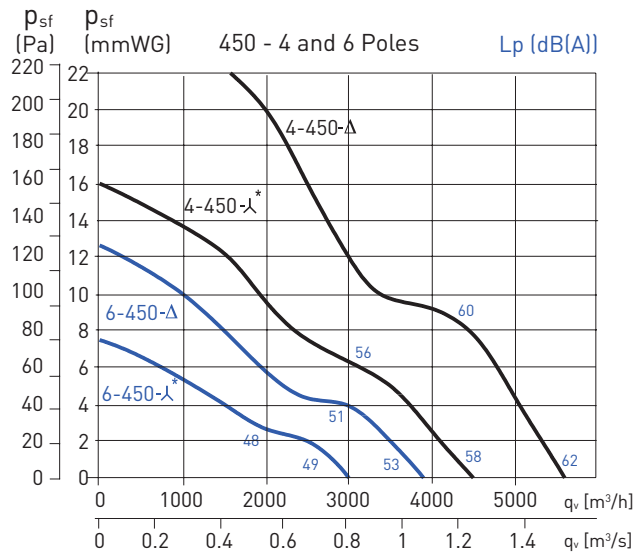
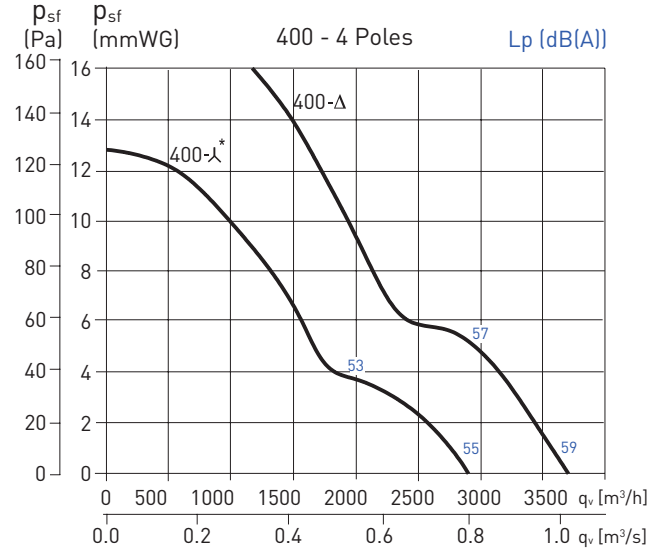
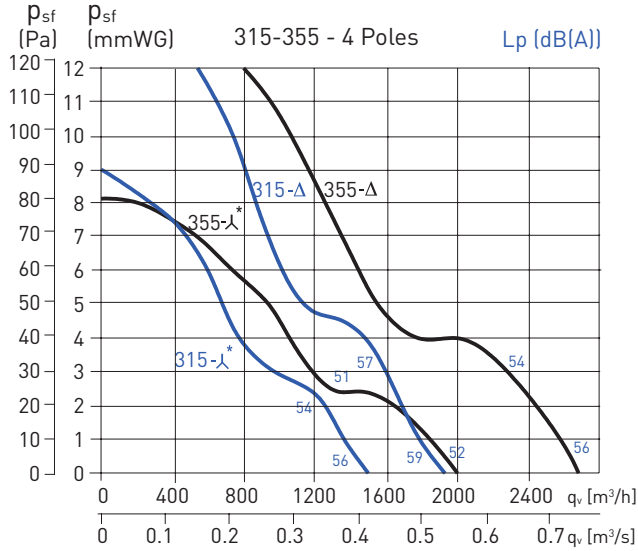

*Low speed: only for three phase models. The values of sound are sound pressure levels measured at 1,5 m, in free field conditions, at the fan inlet side.

PERFORMANCE CURVES – EXTRACT AIR CONFIGURATION (TYPE B)

- q_v : Airflow in m^3/h and m^3/s .
- p_{sf} : Static pressure in mmWG and Pa.
- Dry air at 20°C and 760 mmHg.
- Performance data in accordance with ISO 5801 and AMCA 210-99 Standards.

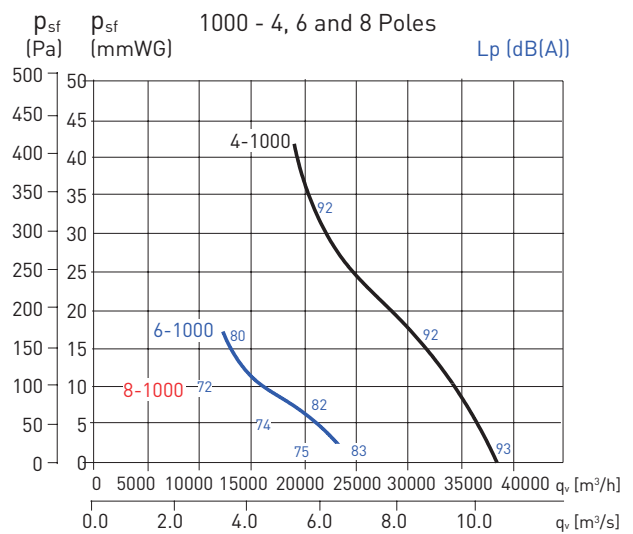
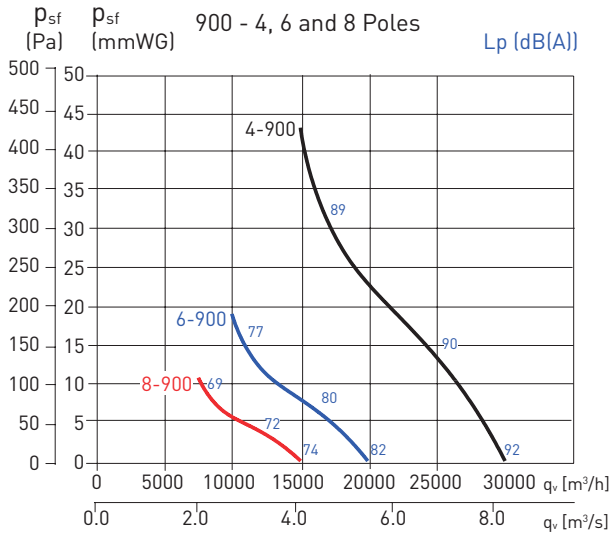
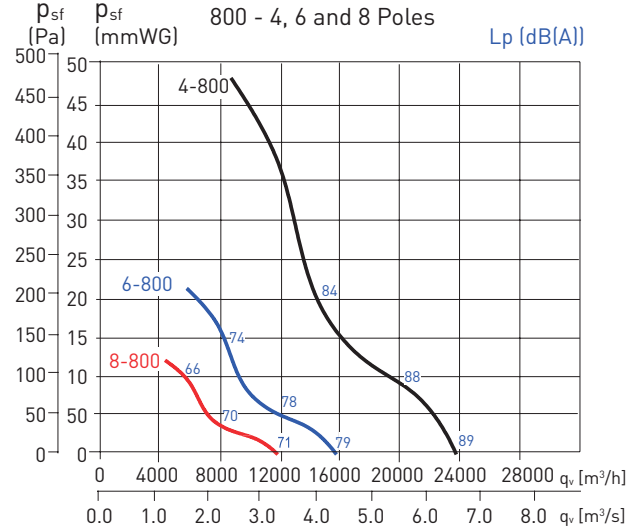
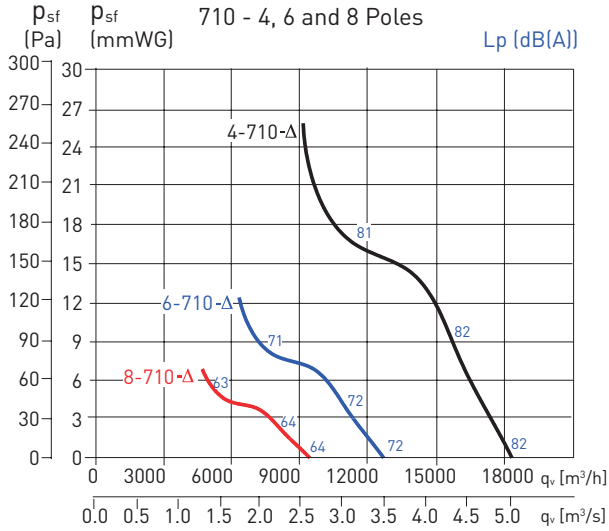

*Low speed: only for three phase models. The values of sound are sound pressure levels measured at 1,5 m, in free field conditions, at the fan inlet side.

PERFORMANCE CURVES – SUPPLY AIR CONFIGURATION (TYPE A)

- q_v : Airflow in m^3/h and m^3/s .
- p_{sf} : Static pressure in mmWG and Pa.
- Dry air at 20°C and 760 mmHg.
- Performance data in accordance with ISO 5801 and AMCA 210-99 Standards.

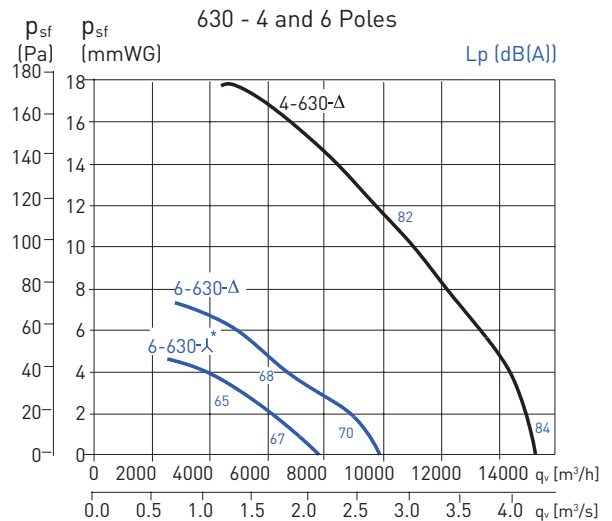
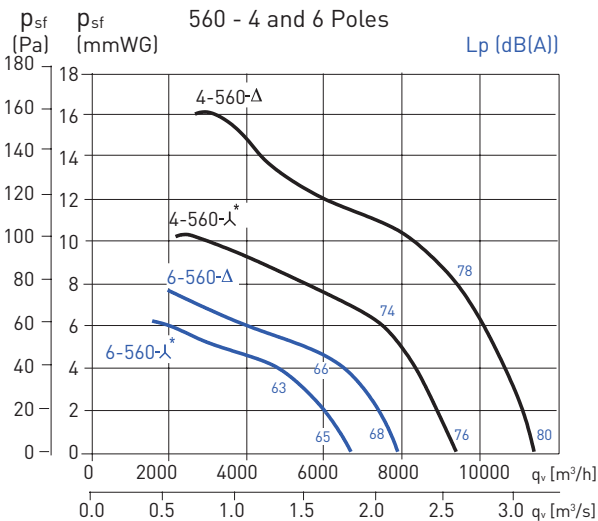
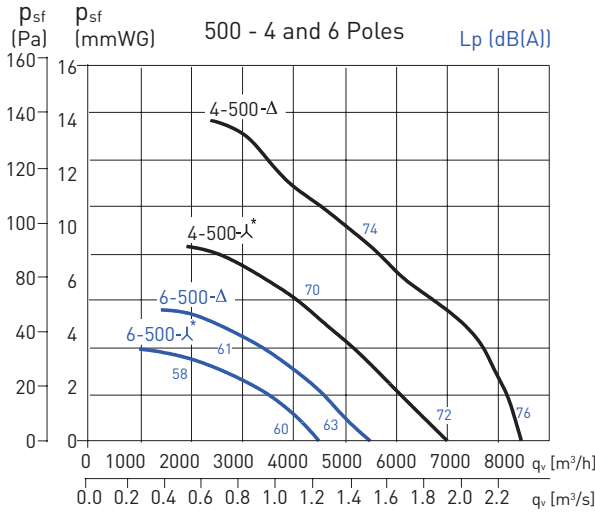
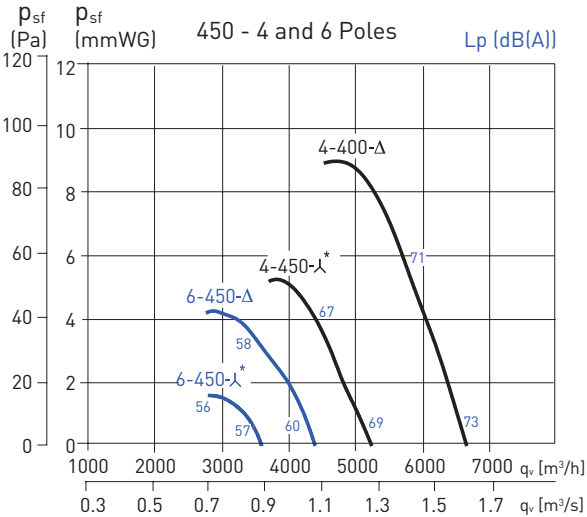
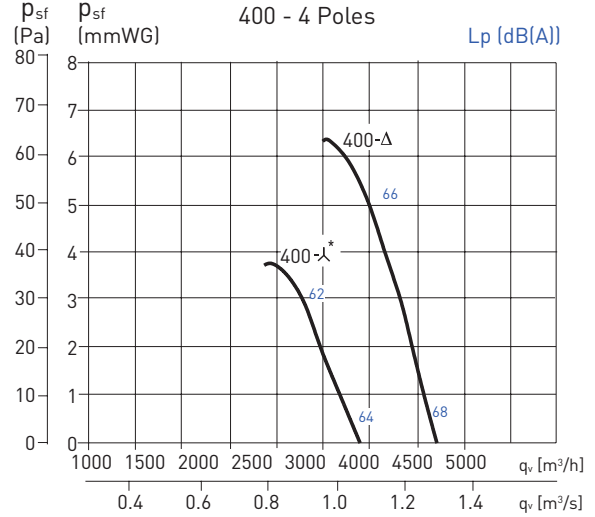
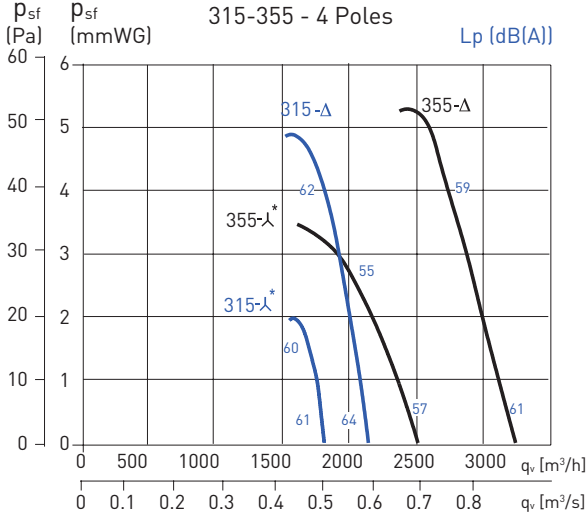

*Low speed: only for three phase models. The values of sound are sound pressure levels measured at 1,5 m, in free field conditions, at the fan inlet side.

PERFORMANCE CURVES – SUPPLY AIR CONFIGURATION (TYPE A)

- q_v : Airflow in m^3/h and m^3/s .
- p_{sf} : Static pressure in mmWG and Pa.
- Dry air at 20°C and 760 mmHg.
- Performance data in accordance with ISO 5801 and AMCA 210-99 Standards.

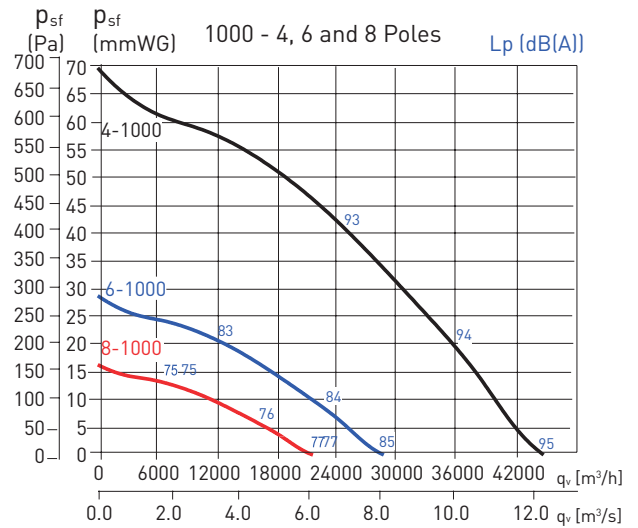
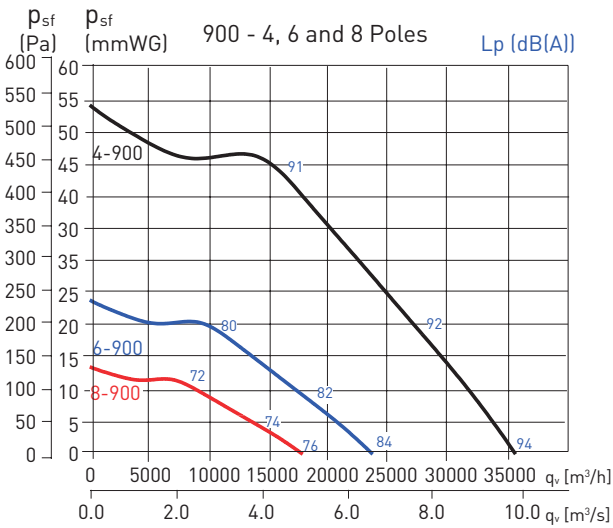
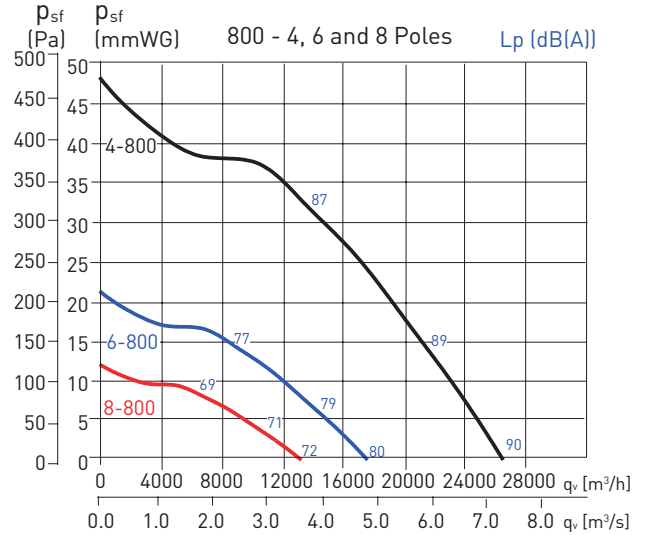
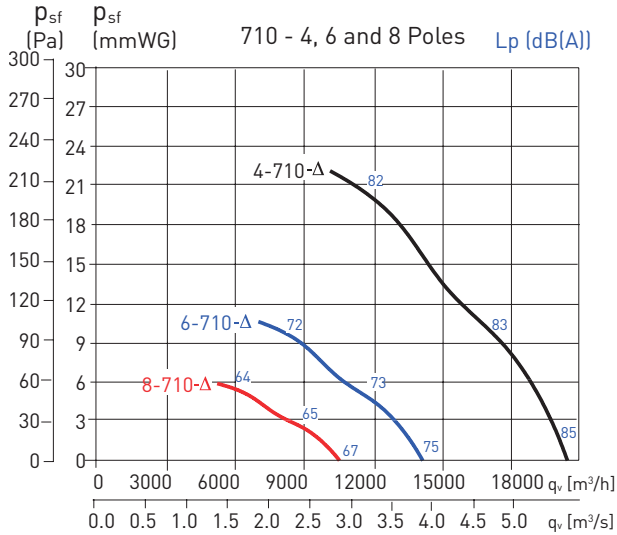

*Low speed: only for three phase models. The values of sound are sound pressure levels measured at 1,5 m, in free field conditions, at the fan inlet side.

ACOUSTIC CHARACTERISTICS

Sound power spectrum: To obtain the sound power level spectrum, add the correction value shown below from value given in the technical characteristics table:

EXTRACT		63	125	250	500	1000	2000	4000	8000	
4 Poles	315	Inlet	41	57	51	73	64	63	58	51
		Outlet	41	53	54	72	62	60	56	50
	355	Inlet	45	56	56	60	65	66	63	56
		Outlet	46	56	63	61	63	64	61	54
	400	Inlet	50	59	58	65	66	69	68	59
		Outlet	51	60	63	65	65	66	66	57
	450	Inlet	52	60	60	67	72	71	69	61
		Outlet	52	63	64	68	70	70	68	61
	500	Inlet	55	64	71	74	80	79	74	66
		Outlet	55	65	72	74	76	75	71	64
	560	Inlet	57	65	75	81	82	81	76	69
		Outlet	57	69	73	76	78	78	75	67
	630	Inlet	63	70	72	79	83	83	81	73
		Outlet	62	73	75	77	80	78	76	71
	710	Inlet	71	82	90	89	93	89	82	73
		Outlet	72	86	89	87	89	86	80	72
	800	Inlet	76	91	96	99	99	95	87	79
		Outlet	77	93	95	94	94	92	86	77
	900	Inlet	77	94	98	102	102	98	91	83
		Outlet	77	96	98	97	97	95	89	80
1000	Inlet	76	93	97	103	103	101	94	86	
	Outlet	78	94	96	97	100	99	93	85	

SUPPLY		63	125	250	500	1000	2000	4000	8000	
4 Poles	315	Outlet	39	61	62	77	68	66	58	52
		Inlet	38	59	65	69	65	60	55	50
	355	Outlet	41	61	64	69	72	71	64	56
		Inlet	40	62	66	67	69	66	61	52
	400	Outlet	47	67	71	75	78	76	69	59
		Inlet	46	66	68	72	74	71	65	54
	450	Outlet	50	71	75	79	82	79	72	64
		Inlet	47	72	72	77	78	73	67	59
	500	Outlet	57	75	80	84	86	83	76	68
		Inlet	56	74	79	81	82	78	71	65
	560	Outlet	58	85	84	87	90	87	79	71
		Inlet	58	80	84	82	85	82	75	66
	630	Outlet	63	86	90	91	94	91	83	73
		Inlet	64	83	89	87	88	85	77	68
	710	Outlet	73	89	92	93	96	92	84	76
		Inlet	71	88	89	87	88	85	78	70
	800	Outlet	73	89	95	100	100	97	91	84
		Inlet	70	91	94	94	93	90	83	75
	900	Outlet	85	93	99	104	104	101	95	88
		Inlet	73	95	97	97	96	94	88	80
1000	Outlet	78	92	99	104	105	104	98	90	
	Inlet	72	94	95	97	99	97	91	83	

EXTRACT		63	125	250	500	1000	2000	4000	8000	
6 Poles	450	Inlet	42	48	54	58	62	64	58	50
		Outlet	44	50	56	58	60	61	57	49
	500	Inlet	45	52	57	60	65	66	62	53
		Outlet	46	53	59	61	63	63	59	52
	560	Inlet	48	56	62	64	70	70	65	57
		Outlet	49	59	63	64	66	67	63	55
	630	Inlet	51	57	65	68	73	74	70	60
		Outlet	53	61	66	67	69	70	68	59
	710	Inlet	61	72	80	79	83	79	72	63
		Outlet	62	76	79	77	79	76	70	62
	800	Inlet	66	81	86	89	89	85	77	69
		Outlet	67	83	85	84	84	82	76	67
	900	Inlet	67	84	88	92	92	88	81	73
		Outlet	67	86	88	87	87	85	79	70
	1000	Inlet	66	83	87	93	93	91	84	76
		Outlet	68	84	86	87	90	89	83	75

SUPPLY		63	125	250	500	1000	2000	4000	8000	
6 Poles	450	Outlet	49	60	65	67	70	67	60	52
		Inlet	44	58	66	65	65	62	55	47
	500	Outlet	54	65	69	71	74	71	62	54
		Inlet	52	63	68	69	69	66	59	50
	560	Outlet	56	70	74	75	78	75	67	59
		Inlet	54	70	72	71	73	70	63	54
	630	Outlet	59	73	78	77	80	77	68	59
		Inlet	57	72	76	73	75	72	64	54
	710	Outlet	63	79	82	83	86	82	74	66
		Inlet	60	77	78	76	77	74	67	59
	800	Outlet	63	79	85	90	90	87	81	74
		Inlet	60	81	84	84	83	80	73	65
	900	Outlet	75	83	89	94	94	91	85	78
		Inlet	63	85	87	87	86	84	78	70
	1000	Outlet	68	82	89	94	95	94	88	80
		Inlet	62	84	85	87	89	87	81	73

EXTRACT		63	125	250	500	1000	2000	4000	8000	
8 Poles	710	Inlet	53	64	72	71	75	71	64	55
		Outlet	54	68	71	69	71	68	62	54
	800	Inlet	58	73	78	81	81	77	69	61
		Outlet	59	75	77	76	76	74	68	59
	900	Inlet	59	76	80	84	84	80	73	65
		Outlet	59	78	80	79	79	77	71	62
	1000	Inlet	58	75	79	85	85	83	76	68
		Outlet	60	76	78	79	82	81	75	67

SUPPLY		63	125	250	500	1000	2000	4000	8000	
8 Poles	710	Outlet	55	71	74	75	78	74	66	58
		Inlet	52	69	70	68	69	66	59	51
	800	Outlet	55	71	77	82	82	79	73	66
		Inlet	52	73	76	76	75	72	65	57
	900	Outlet	67	75	81	86	86	83	77	70
		Inlet	55	77	79	79	78	76	70	62
	1000	Outlet	60	74	81	86	87	86	80	72
		Inlet	54	76	77	79	81	79	73	65

DIMENSIONS (mm)

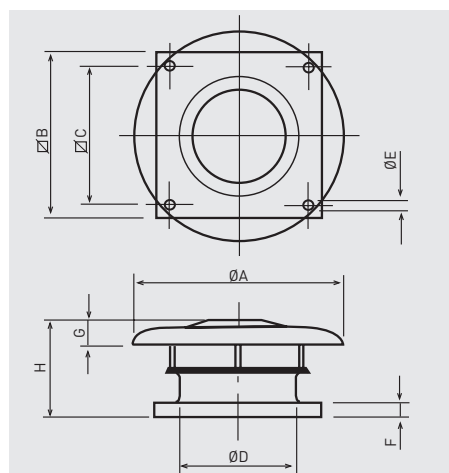

Model	Ø A	□ B	□ C	Ø D	Ø E	F	G	H
315	640	560	450	315	12	40	70	352
355	760	630	535	355	12	40	80	372
400	760	630	535	400	12	40	80	372
450	895	710	590	450	14	40	110	416
500	895	710	590	500	14	40	110	436
560	1150	905	750	560	14	50	165	508
630	1150	905	750	630	14	50	165	508
710	1350	1100	840	710	14	50	200	549
800	1350	1100	840	800	14	50	200	729
900	1580	1250	950	900	14	50	200	763
1000	1580	1250	950	1000	14	50	200	763

MOUNTING ACCESSORIES

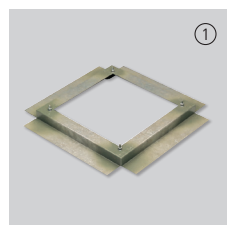

- JMS Sealing frame**
- For mounting a roof fan on an up stand or base.
 - Supplied with screws and gasket for a complete weatherproof seal.

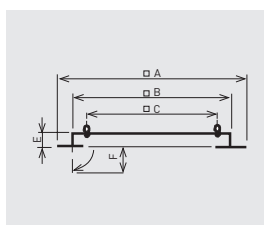

Model	□ A	□ B	□ C	E	F
JMS-560	725	545	450	50	70
JMS-630	795	615	535	50	70
JMS-710	875	695	590	50	70
JMS-905	1065	885	750	60	70
JMS-1100	1260	1080	840	60	70
JMS-1250	1410	1230	950	60	70



- JBS Flat roof up stand**
- For mounting a fan on a flat roof without up stands.
 - For use on horizontal roofs.
 - Internal insulation to prevent condensation.
 - Supplied with screws and gasket for a complete weather seal.

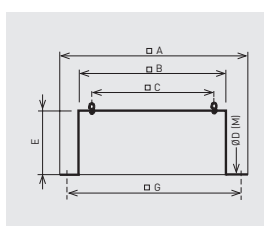

Model	□ A	□ B	□ C	Ø D (M)	E	□ G
JBS-560	725	544	450	11 (M10)	300	635
JBS-630	795	614	535	11 (M10)	300	705
JBS-710	875	694	590	16 (M10)	300	785
JBS-905	1065	884	750	16 (M10)	400	975
JBS-1100	1260	1079	840	16 (M10)	400	1170
JBS-1250	1410	1230	950	16 (M10)	300	1320



- JPA Accessory adapter plate**
- Used when mounting the accessories (JCA, JBR, JAE).
 - Allows the fan to be disconnected from the up stand without having to remove the duct.

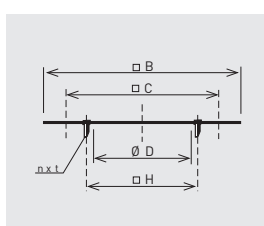

Model	□ B	□ C	Ø D	n x L	Ø H
JPA-560	544	450	358	8xM8	395
JPA-630	614	535	403	8xM10	450
JPA-710	694	590	503	12xM10	560
JPA-905	884	750	633	12xM10	690
JPA-1100	1079	840	713	16xM10	770
JPA-1250	1130	950	1000	8xM12	1070

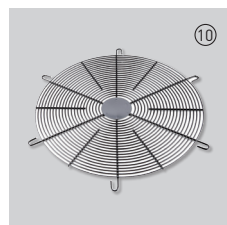

- Protection Defense DEF.ASP.THGT**
- JPA adapter plate is required for installation.
 - Recommended for free aspiration installations as a safety measure.

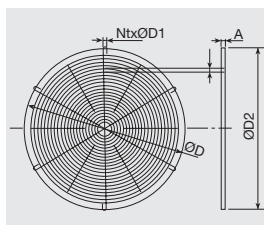

Model	A	B	Ø D	n x ØD1	Ø D2
DEF.ASP.THGT-355	5	10	395	4 X 10	340
DEF.ASP.THGT-400	5	10	450	4 X 12	400
DEF.ASP.THGT-500	5	10	560	6 X 12	500
DEF.ASP.THGT-630	5	10	690	6 X 12	630
DEF.ASP.THGT-710	5	10	770	8 X 12	720
DEF.ASP.THGT-1000	5	10	1070	8 X 12	1010



- JCA N Backdraft shutter**
- Prevents backdraft when the fan is not operating.
 - To be mounted at the fan inlet with the JPA plate.

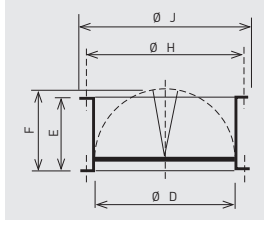

Model	Ø D	E	F	Ø H	Ø J
JCA-560 N	358	210	227	395	415
JCA-630 N	403	240	250	450	474
JCA-710 N	503	285	300	560	581
JCA-905 N	633	345	365	690	714
JCA-1100 N	713	390	410	770	806
JCA-1250 N	1004	560	560	1070	1110

MOUNTING ACCESSORIES



**JBR N
Flange**

- For use when circular connection is required directly to the fan.
- To be mounted at the fan inlet with the JPA plate or fixed directly to the fan base (rivets or screws not supplied).

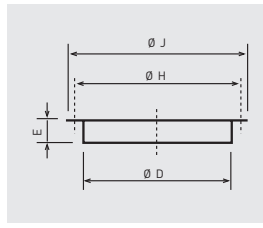

Model	Ø D	E	Ø H	Ø J
JBR-560 N	358	55	395	415
JBR-630 N	403	63	450	474
JBR-710 N	503	69	560	581
JBR-905 N	633	69	690	714
JBR-1100 N	713	69	770	797
JBR-1250 N	1004	105	1070	1110



**JAE N
Flexible coupling**

- Reduces the transmission of vibrations when the duct is connected directly to the fan.
- To be mounted at the fan inlet with JPA plate.

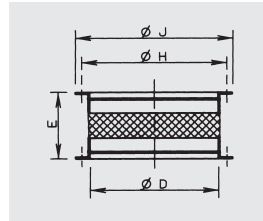

Model	Ø D	E	Ø H	Ø J
JAE-560 N	358	164	395	415
JAE-630 N	403	164	450	474
JAE-710 N	503	164	560	581
JAE-905 N	633	164	690	714
JAE-1100 N	713	185	770	797
JAE-1250 N	1000	185	1070	1110

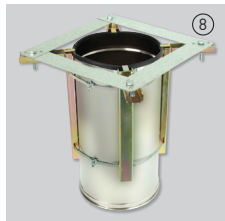

**JCC
Adapter for circular duct**

- For use when fitting the models up to 400, directly to a spirally wound circular duct.

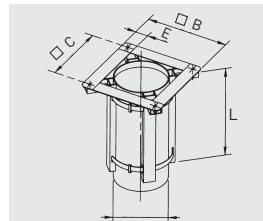

Model	Ø B	Ø C	Ø D	E	L
JCC-560	520	450	355	70	350
JCC-630	605	535	400	70	350



**BI
Support base for inclined curb mounted installations**

- To ensure a proper installation of the product it is essential to specify the roof pitch angle and the distance between the roof beam profiles.

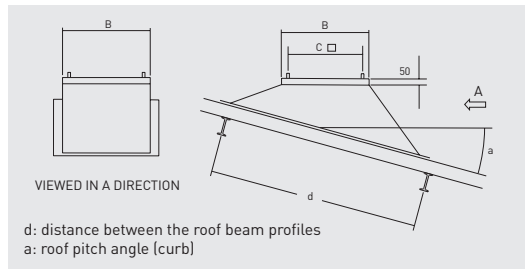

Model	B	C
BI-5	544	450
BI-6	614	535
BI-7	694	590
BI-9	884	750
BI-11	1079	840
BI-12	1230	950



**JAA
Acoustic up stand**

- Reduces in duct and radiated noise.
- For use when mounting a fan on a flat roof without up stands.
- Supplied with screws and gasket for a complete weather seal.

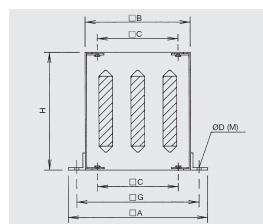

Model	Ø A	Ø B	Ø C	Ø D (M)	H	Ø G
JAA-560	725	545	450	15 (M12)	750	635
JAA-630	795	615	535	15 (M12)	750	705
JAA-710	875	695	590	18 (M14)	1000	785
JAA-905	1065	885	750	18 (M14)	1000	975
JAA-1100	1260	1080	840	18 (M14)	1000	1170
JAA-1250	1410	1230	950	18 (M14)	1000	1320

Acoustic attenuation in dB(A) at the corresponding frequency band in (Hz).

Model	125	250	500	1000	2000	4000	8000
JAA-560	2	8	16	29	32	26	17
JAA-630	2	8	14	24	27	19	13
JAA-710	2	8	14	24	28	16	11
JAA-905	2	7	14	26	30	19	12
JAA-1100	2	7	16	27	32	20	13
JAA-1250	2	7	16	24	21	11	6

JAA Attenuator pressure drops

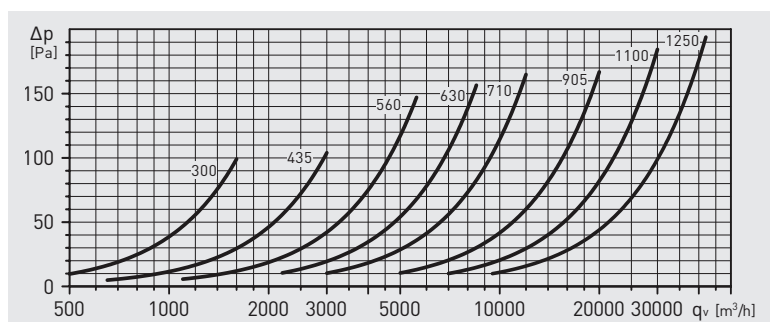

INSTALLATION

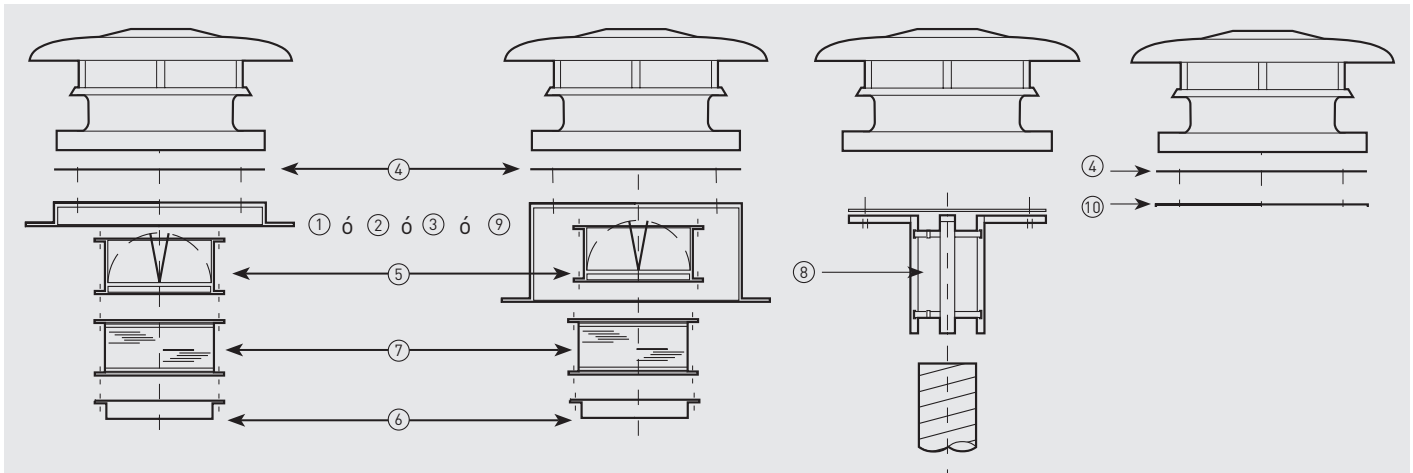

Model of fan	① Sealing frame	② Flat roof insulated up stand	③ Acoustic up stand	④ Accessory adapter shutter	⑤ Back draft shutter	⑥ Flange with spigot	⑦ Flexible coupling	⑧ Circular adapter	⑨ Support base for inclined curb mounted installations	⑩ Protection defense
315	JMS-560	JBS-560	JAA-560	JPA-560	JCA-560 N	JBR-560 N	JAE-560 N	JCC-560	BI-5	DEF.ASP.THGT-355
355 400	JMS-630	JBS-630	JAA-630	JPA-630	JCA-630 N	JBR-630 N	JAE-630 N	JCC-630	BI-6	DEF.ASP.THGT-400
450 500	JMS-710	JBS-710	JAA-710	JPA-710	JCA-710 N	JBR-710 N	JAE-710 N	-	BI-7	DEF.ASP.THGT-500
560 630	JMS-905	JBS-905	JAA-905	JPA-905	JCA-905 N	JBR-905 N	JAE-905 N	-	BI-9	DEF.ASP.THGT-630
710 800	JMS-1100	JBS-1100	JAA-1100	JPA-1100	JCA-1100 N	JBR-1100 N	JAE-1100 N	-	BI-11	DEF.ASP.THGT-710
900 1000	JMS-1250	JBS-1250	JAA-1250	JPA-1250	JCA-1250 N	JBR-1250 N	JAE-1250 N	-	BI-12	DEF.ASP.THGT-1000

ELECTRICAL ACCESSORIES



REB
Single phase electronic speed controllers.



RMB / RMT
Auto transformer speed controllers available in single phase and three phase motors.



On/ Off Electrical isolation switch
- Switch On/ Off 5P.
- Switch On/ Off 8P.



COM D/S
Three phase fan Y / Δ switch
Enables to connect three phase fans.



VFTM IP54
Adjustable frequency drives for three phase motors from 0,37 to 15 kW.



VFKB IP65
Adjustable frequency drive for three phase motors from 0,37 to 4 kW.



DEMA DH
Switch for 2-speed motors with Dahlander.