



Range of in-line rectangular duct fan manufactured from galvanised steel sheet and provided with an inspection cover that can be removed to access the motor/impeller assembly without having to remove the complete fan casing from the ducting. All model incorporate direct-drive forward curved centrifugal impeller.

Motors

Available, depending upon the model, in 4, 6 or 8 poles.

Three phase motors are speed controllable by inverter.

All motors are IP55, class F insulation, equipped with thermal protection.

All motors incorporate ball bearings greased for life.

Electrical supply:

Single phase 230V-50Hz.

Three phase 230/400V-50Hz.

(See characteristics chart).

All single and three phase motors are speed controllable by voltage. And all three phase motors are also suitable for inverter control.

For ATEX versions, please see ILT ATEX Series



Easy to install

Standard rectangular flanges to ease the Installation.



IP55 remote terminal box

To ease installation and maintenance and connection to external controls.



Inspection cover

To facilitate maintenance.



Complete solution for ventilation systems

In-line ILB / ILT fan mounted together with a bag filter IFL, an acoustic attenuator IAA, a flexible connector IAE and an electric heater IBE.

TECHNICAL CHARACTERISTICS

Before installation check that the product electrical characteristics listed on the data plate label (voltage, power, frequency, etc.) match those of the intended electrical supply.

Model	Nominal ducting dimensions	Speed (rpm)	Maximum absorbed power (W)	Maximum absorbed current (A)		Maximum airflow (m ³ /h)	Sound pressure level* (dB(A))	Minimum and maximum operating temperature (°C)	Weight (kg)	Speed controller	Variable frequency inverter
				to 230 V	to 400 V						
4 POLE SINGLE PHASE											
ILB/4-200	400 x 200	1240	240	1,15	–	1.090	57	-40/+70	15	RMB-1,5	-
ILB/4-225	500 x 250	1130	520	2,45	–	1.670	56	-40/+70	20	RMB-3,5	-
ILB/4-250	500 x 300	1130	950	4,4	–	2.350	60	-40/+70	25	RMB-8	-
6 POLE SINGLE PHASE											
ILB/6-225	500 x 250	800	200	1	–	1.080	48	-40/+70	20	RMB-1,5	-
ILB/6-250	500 x 300	800	310	1,5	–	1.500	49	-40/+70	25	RMB-3,5	-
ILB/6-285	600 x 300	825	660	3,2	–	2.650	55	-40/+70	32	RMB-3,5	-
ILB/6-315	600 x 350	810	710	3,4	–	2.780	57	-40/+70	40	RMB-8	-
ILB/6-355	700 x 400	800	1300	6,3	–	4.070	60	-40/+70	60	RMB-8	-
4 POLE THREE PHASE											
ILT/4-200	400 x 200	1270	260	1	0,6	1.150	59	-40/+70	15	RMT-1,5	VFTM TRI 0,37
ILT/4-225	500 x 250	1160	500	1,7	1	1.700	58	-40/+70	20	RMT-1,5	VFTM TRI 0,37
ILT/4-250	500 x 300	1170	930	3	1,8	2.650	62	-40/+70	25	RMT-2,5	VFTM TRI 0,55
ILT/4-285	600 x 300	1070	1260	4,2	2,4	3.100	61	-40/+70	32	RMT-5	VFTM TRI 1,1
ILT/4-315	600 x 350	1390	2440	8	4,6	4.160	68	-40/+70	42	RMT-5	VFTM TRI 2,2
ILT/4-355	700 x 400	1330	5690		9,1	7.760	70	-20/+60	65	RMT-12	VFTM TRI 5,5
ILT/4-400	800 x 500	1350	6350		9,3	7.765	69	-20/+60	80	RMT-12	VFTM TRI 5,5
ILT/4-450	1000 x 500	1360	8360		14,6	8.940	66	-20/+60	100	-	VFTM TRI 7,5
6 POLE THREE PHASE											
ILT/6-225	500 x 250	840	220	1	0,6	1.185	50	-40/+70	20	RMT-1,5	VFTM TRI 0,37
ILT/6-250	500 x 300	800	280	1	0,6	1.630	51	-40/+70	25	RMT-1,5	VFTM TRI 0,37
ILT/6-285	600 x 300	840	670	2,3	1,3	2.700	56	-40/+70	32	RMT-1,5	VFTM TRI 0,37
ILT/6-315	600 x 350	900	710	2,5	1,4	2.820	57	-40/+70	40	RMT-2,5	VFTM TRI 0,55
ILT/6-355	700 x 400	875	1380	5,2	3	4.200	61	-40/+70	65	RMT-5	VFTM TRI 1,5
ILT/6-400	800 x 500	950	3000	11	6,4	7.400	66	-20/+60	80	RMT-8	VFTM TRI 3
ILT/6-450	1000 x 500	900	5350	17,3	10	10.850	67	-20/+40	100	RMT-12	VFTM TRI 5,5
8 POLE THREE PHASE											
ILT/8-355	700 x 400	660	614	2,4	1,4	3.030	52	-40/+70	65	RMT-2,5	VFTM TRI 0,37
ILT/8-400	800 x 500	700	1340	6,4	3,7	5.350	59	-20/+70	80	RMT-5	VFTM TRI 2,2
ILT/8-450	1000 x 500	675	2380	7,7	4,5	8.000	61	-20/+70	100	RMT-8	VFTM TRI 2,2

* Measured at 1 m at free field, with ducted inlet and outlet.

DIMENSIONS (mm)

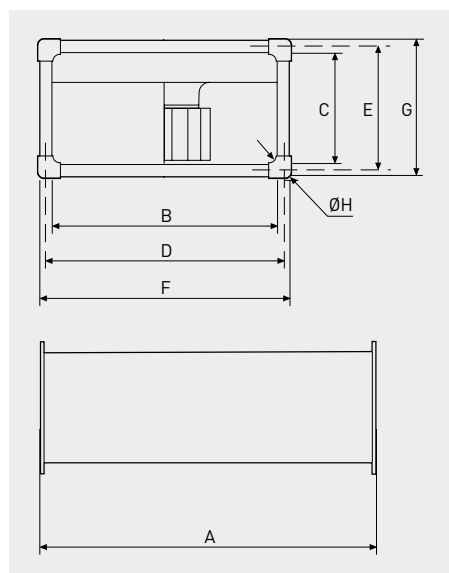

Model	A	B	C	D	E	F	G	ØH
200	505	400	198	420	220	440	240	9
225	535	500	248	520	270	540	290	9
250	565	500	298	520	320	540	340	9
285	645	600	298	620	320	640	340	9
315	725	600	348	620	370	640	390	9
355	785	700	398	720	420	740	440	9
400	885	800	498	820	520	840	540	9
450	985	1000	498	1020	520	1040	540	9

ACOUSTIC CHARACTERISTICS

The sound power spectrum in dB (A), at the fan inlet, discharge and radiated at 3 working points of the performance curve (A: maximum volume). The sound levels shown on the curves are radiated sound pressure levels, measured at 1 m, in free field conditions.

ILB/4-200		63	125	250	500	1.000	2.000	4.000	8.000
Inlet	A	50	61	65	70	71	67	62	54
	B	50	61	65	70	71	67	62	54
	C	46	57	61	66	67	63	58	50
	D	41	52	56	61	62	58	53	45
Outlet	A	46	61	64	70	76	72	70	63
	B	46	61	64	70	76	72	70	63
	C	43	58	61	67	73	69	67	60
	D	39	54	57	63	69	65	63	56
Radiated	A	50	54	56	58	63	63	58	48
	B	49	53	55	57	62	62	57	47
	C	46	50	52	54	59	59	54	44
	D	41	45	47	49	54	54	49	39

ILT/4-200		63	125	250	500	1.000	2.000	4.000	8.000
Inlet	A	52	63	67	72	73	69	64	56
	B	50	61	65	70	71	67	62	54
	C	46	57	61	66	67	63	58	50
	D	41	52	56	61	62	58	53	45
Outlet	A	48	63	66	72	78	74	72	65
	B	46	61	64	70	76	72	70	63
	C	43	58	61	67	73	69	67	60
	D	39	54	57	63	69	65	63	56
Radiated	A	52	56	58	60	65	65	60	50
	B	50	54	56	58	63	63	58	48
	C	46	50	52	54	59	59	54	44
	D	41	45	47	49	54	54	49	39

ILB/4-225		63	125	250	500	1.000	2.000	4.000	8.000
Inlet	A	51	63	66	71	72	69	64	55
	B	52	64	67	72	73	70	65	56
	C	49	61	64	69	70	67	62	53
	D	45	57	60	65	66	63	58	49
Outlet	A	47	62	65	71	76	73	71	64
	B	48	63	66	72	77	74	72	65
	C	46	61	64	70	75	72	70	63
	D	42	57	60	66	71	68	66	59
Radiated	A	51	56	57	59	62	62	57	47
	B	52	57	58	60	63	63	58	48
	C	49	54	55	57	60	60	55	45
	D	44	49	50	52	55	55	50	40

ILT/4-225		63	125	250	500	1.000	2.000	4.000	8.000
Inlet	A	52	64	67	72	73	70	65	56
	B	51	63	66	71	72	69	64	55
	C	48	60	63	68	69	66	61	52
	D	44	56	59	64	65	62	57	48
Outlet	A	48	63	66	72	77	74	72	65
	B	48	63	66	72	77	74	72	65
	C	45	60	63	69	74	71	69	62
	D	42	57	60	66	71	68	66	59
Radiated	A	52	57	58	60	63	63	58	48
	B	51	56	57	59	62	62	57	47
	C	48	53	54	56	59	59	54	44
	D	44	49	50	52	55	55	50	40

ILB/4-250		63	125	250	500	1.000	2.000	4.000	8.000
Inlet	A	55	67	69	74	75	74	69	60
	B	55	67	69	74	75	74	69	60
	C	53	65	67	72	73	72	67	58
	D	49	61	63	68	69	68	63	54
Outlet	A	51	66	68	76	79	78	75	68
	B	52	67	69	77	80	79	76	69
	C	50	65	67	75	78	77	74	67
	D	46	61	63	71	74	73	70	63
Radiated	A	56	61	61	64	65	64	60	51
	B	56	61	61	64	65	64	60	51
	C	54	59	59	62	63	62	58	49
	D	49	54	54	57	58	57	53	44

ILT/4-250		63	125	250	500	1.000	2.000	4.000	8.000
Inlet	A	58	70	72	77	78	77	72	63
	B	57	69	71	76	77	76	71	62
	C	54	66	68	73	74	73	68	59
	D	49	61	63	68	69	68	63	54
Outlet	A	54	69	71	79	82	81	78	71
	B	53	68	70	78	81	80	77	70
	C	51	66	68	76	79	78	75	68
	D	47	62	64	72	75	74	71	64
Radiated	A	58	63	63	66	67	66	62	53
	B	57	62	62	65	66	65	61	52
	C	54	59	59	62	63	62	58	49
	D	49	54	54	57	58	57	53	44

ILB/4-285		63	125	250	500	1.000	2.000	4.000	8.000
Inlet	A	58	70	72	76	77	77	73	68
	B	59	71	73	77	78	78	74	69
	C	58	70	72	76	77	77	73	68
	D	54	66	68	72	73	73	69	64
Outlet	A	54	69	71	80	82	81	78	71
	B	56	71	73	82	84	83	80	73
	C	55	70	72	81	83	82	79	72
	D	51	66	68	77	79	78	75	68
Radiated	A	58	65	65	66	62	62	60	57
	B	59	66	66	67	63	63	61	58
	C	58	65	65	66	62	62	60	57
	D	53	60	60	61	57	57	55	52

ILT/4-315		63	125	250	500	1.000	2.000	4.000	8.000
Inlet	A	65	77	79	83	84	84	80	75
	B	63	75	77	81	82	82	78	73
	C	60	72	74	78	79	79	75	70
	D	54	66	68	72	73	73	69	64
Outlet	A	61	76	78	87	89	88	85	78
	B	60	75	77	86	88	87	84	77
	C	57	72	74	83	85	84	81	74
	D	52	67	69	78	80	79	76	69
Radiated	A	65	72	72	73	69	69	67	64
	B	63	70	70	71	67	67	65	62
	C	60	67	67	68	64	64	62	59
	D	55	62	62	63	59	59	57	54

ACOUSTIC CHARACTERISTICS

The sound power spectrum in dB (A), at the fan inlet, discharge and radiated at 3 working points of the performance curve (A: maximum volume). The sound levels shown on the curves are radiated sound pressure levels, measured at 1 m, in free field conditions.

ILT/4-355		63	125	250	500	1.000	2.000	4.000	8.000
Inlet	A	66	78	83	86	89	90	87	83
	B	65	77	80	82	85	85	83	79
	C	64	77	75	78	81	80	78	73
	D	65	77	79	81	84	84	82	78
Outlet	A	71	79	85	90	94	93	90	85
	B	67	78	81	86	91	89	86	81
	C	62	75	75	81	86	83	81	74
	D	66	77	80	85	90	88	85	80
Radiated	A	66	71	71	72	74	76	73	68
	B	65	70	68	68	70	71	69	64
	C	64	70	63	64	66	66	64	58
	D	65	70	67	67	69	70	68	63

ILT/4-400		63	125	250	500	1.000	2.000	4.000	8.000
Inlet	A	68	78	80	82	89	88	85	80
	B	67	77	77	79	86	84	81	76
	C	64	74	75	77	84	82	79	74
Outlet	A	78	82	85	89	93	91	87	82
	B	72	78	80	85	90	87	83	77
	C	71	76	78	83	87	85	81	75
Radiated	A	63	68	68	71	74	73	70	70
	B	62	67	65	68	71	69	66	66
	C	58	63	62	65	68	67	64	64

ILT/4-450		63	125	250	500	1.000	2.000	4.000	8.000
Inlet	A	78	77	80	81	88	86	82	77
	B	78	77	78	80	87	85	81	76
Outlet	A	77	80	84	89	94	93	87	81
	B	76	79	83	88	93	92	86	80
Radiated	A	70	68	67	62	71	69	64	60
	B	70	68	65	61	70	68	63	59

ILB/6-225		63	125	250	500	1.000	2.000	4.000	8.000
Inlet	A	46	54	57	62	63	60	55	43
	B	47	55	58	63	64	61	56	44
	C	44	52	55	60	61	58	53	41
	D	39	47	50	55	56	53	48	36
Outlet	A	40	53	56	62	67	64	62	53
	B	41	54	57	63	68	65	63	54
	C	38	51	54	60	65	62	60	51
	D	34	47	50	56	61	58	56	47
Radiated	A	46	47	48	50	53	53	48	35
	B	46	47	48	50	53	53	48	35
	C	43	44	45	47	50	50	45	32
	D	39	40	41	43	46	46	41	28

ILT/6-225		63	125	250	500	1.000	2.000	4.000	8.000
Inlet	A	48	56	59	64	65	62	57	45
	B	46	54	57	62	63	60	55	43
	C	44	52	55	60	61	58	53	41
	D	39	47	50	55	56	53	48	36
Outlet	A	41	54	57	63	68	65	63	54
	B	40	53	56	62	67	64	62	53
	C	38	51	54	60	65	62	60	51
	D	34	47	50	56	61	58	56	47
Radiated	A	48	49	50	52	55	55	50	37
	B	46	47	48	50	53	53	48	35
	C	43	44	45	47	50	50	45	32
	D	39	40	41	43	46	46	41	28

ILB/6-250		63	125	250	500	1.000	2.000	4.000	8.000
Inlet	A	49	57	59	64	65	64	59	47
	B	50	58	60	65	66	65	60	48
	C	47	55	57	62	63	62	57	45
	D	43	51	53	58	59	58	53	41
Outlet	A	43	56	58	66	69	68	65	56
	B	44	57	59	67	70	69	66	57
	C	42	55	57	65	68	67	64	55
	D	38	51	53	61	64	63	60	51
Radiated	A	49	50	50	53	53	53	49	37
	B	50	51	51	54	54	54	50	38
	C	48	49	49	52	52	52	48	36
	D	43	44	44	47	47	47	43	31

ILT/6-250		63	125	250	500	1.000	2.000	4.000	8.000
Inlet	A	51	59	61	66	67	66	61	49
	B	50	58	60	65	66	65	60	48
	C	47	55	57	62	63	62	57	45
	D	43	51	53	58	59	58	53	41
Outlet	A	44	57	59	67	70	69	66	57
	B	44	57	59	67	70	69	66	57
	C	42	55	57	65	68	67	64	55
	D	38	51	53	61	64	63	60	51
Radiated	A	51	52	52	55	55	55	51	39
	B	50	51	51	54	54	54	50	38
	C	48	49	49	52	52	52	48	36
	D	43	44	44	47	47	47	43	31

ILB/6-285		63	125	250	500	1.000	2.000	4.000	8.000
Inlet	A	54	64	66	70	71	71	67	60
	B	54	64	66	70	71	71	67	60
	C	51	61	63	67	68	68	64	57
	D	46	56	58	62	63	63	59	52
Outlet	A	50	63	65	74	76	75	72	63
	B	50	63	65	74	76	75	72	63
	C	47	60	62	71	73	72	69	60
	D	43	56	58	67	69	68	65	56
Radiated	A	54	58	59	60	56	56	54	49
	B	54	58	59	60	56	56	54	49
	C	51	55	56	57	53	53	51	46
	D	46	50	51	52	48	48	46	41

ILT/6-285		63	125	250	500	1.000	2.000	4.000	8.000
Inlet	A	55	65	67	71	72	72	68	61
	B	54	64	66	70	71	71	67	60
	C	51	61	63	67	68	68	64	57
	D	45	55	57	61	62	62	58	51
Outlet	A	51	64	66	75	77	76	73	64
	B	51	64	66	75	77	76	73	64
	C	47	60	62	71	73	72	69	60
	D	43	56	58	67	69	68	65	56
Radiated	A	55	59	60	61	57	57	55	50
	B	54	58	59	60	56	56	54	49
	C	51	55	56	57	53	53	51	46
	D	46	50	51	52	48	48	46	41

ACOUSTIC CHARACTERISTICS

The sound power spectrum in dB (A), at the fan inlet, discharge and radiated at 3 working points of the performance curve (A: maximum volume).
The sound levels shown on the curves are radiated sound pressure levels, measured at 1 m, in free field conditions.

ILB/6-315		63	125	250	500	1.000	2.000	4.000	8.000
Inlet	A	56	66	68	72	73	73	69	62
	B	55	65	67	71	72	72	68	61
	C	52	62	64	68	69	69	65	58
	D	52	62	64	68	69	69	65	58
Outlet	A	52	65	67	76	78	77	74	65
	B	51	64	66	75	77	76	73	64
	C	48	61	63	72	74	73	70	61
	D	44	57	59	68	70	69	66	57
Radiated	A	56	60	61	62	58	58	56	51
	B	55	59	60	61	57	57	55	50
	C	52	56	57	58	54	54	52	47
	D	47	51	52	53	49	49	47	42

ILT/6-315		63	125	250	500	1.000	2.000	4.000	8.000
Inlet	A	56	66	68	72	73	73	69	62
	B	55	65	67	71	72	72	68	61
	C	51	61	63	67	68	68	64	57
	D	46	56	58	62	63	63	59	52
Outlet	A	52	65	67	76	78	77	74	65
	B	51	64	66	75	77	76	73	64
	C	48	61	63	72	74	73	70	61
	D	44	57	59	68	70	69	66	57
Radiated	A	56	60	61	62	58	58	56	51
	B	55	59	60	61	57	57	55	50
	C	52	56	57	58	54	54	52	47
	D	47	51	52	53	49	49	47	42

ILB/6-355		63	125	250	500	1.000	2.000	4.000	8.000
Inlet	A	60	69	72	76	77	77	73	67
	B	59	68	71	75	76	76	72	66
	C	56	65	68	72	73	73	69	63
	D	50	59	62	66	67	67	63	57
Outlet	A	58	70	73	81	83	82	79	71
	B	57	69	72	80	82	81	78	70
	C	54	66	69	77	79	78	75	67
	D	49	61	64	72	74	73	70	62
Radiated	A	58	63	65	64	61	60	58	55
	B	57	62	64	63	60	59	57	54
	C	54	59	61	60	57	56	54	51
	D	48	53	55	54	51	50	48	45

ILT/6-355		63	125	250	500	1.000	2.000	4.000	8.000
Inlet	A	61	70	73	77	78	78	74	68
	B	59	68	71	75	76	76	72	66
	C	56	65	68	72	73	73	69	63
	D	50	59	62	66	67	67	63	57
Outlet	A	58	70	73	81	83	82	79	71
	B	57	69	72	80	82	81	78	70
	C	54	66	69	77	79	78	75	67
	D	49	61	64	72	74	73	70	62
Radiated	A	59	64	66	65	62	61	59	56
	B	57	62	64	63	60	59	57	54
	C	54	59	61	60	57	56	54	51
	D	48	53	55	54	51	50	48	45

ILB/6-400		63	125	250	500	1.000	2.000	4.000	8.000
Inlet	A	70	75	79	83	86	85	81	75
	B	68	73	77	81	84	83	79	73
	C	64	69	73	77	80	79	75	69
	D	58	63	67	71	74	73	69	63
Outlet	A	69	76	81	88	90	89	85	77
	B	68	75	80	87	89	88	84	76
	C	64	71	76	83	85	84	80	72
	D	59	66	71	78	80	79	75	67
Radiated	A	66	68	70	71	69	67	64	62
	B	64	66	68	69	67	65	62	60
	C	64	66	68	69	67	65	62	60
	D	54	56	58	59	57	55	52	50

ILT/6-450		63	125	250	500	1.000	2.000	4.000	8.000
Inlet	A	74	76	81	85	88	87	83	77
	B	73	75	80	84	87	86	82	76
	C	70	72	77	81	84	83	79	73
	D	64	66	71	75	78	77	73	67
Outlet	A	75	79	85	91	93	92	87	80
	B	74	78	84	90	92	91	86	79
	C	71	75	81	87	89	88	83	76
	D	66	70	76	82	84	83	78	71
Radiated	A	68	69	72	73	70	67	65	63
	B	67	68	71	72	69	66	64	62
	C	64	65	68	69	66	63	61	59
	D	58	59	62	63	60	57	55	53

ILB/8-355		63	125	250	500	1.000	2.000	4.000	8.000
Inlet	A	54	61	64	68	69	69	65	56
	B	53	60	63	67	68	68	64	55
	C	50	57	60	64	65	65	61	52
	D	45	52	55	59	60	60	56	47
Outlet	A	50	61	64	72	74	73	70	60
	B	50	61	64	72	74	73	70	60
	C	47	58	61	69	71	70	67	57
	D	42	53	56	64	66	65	62	52
Radiated	A	52	54	57	56	53	52	50	44
	B	51	53	56	55	52	51	49	43
	C	48	50	53	52	49	48	46	40
	D	43	45	48	47	44	43	41	35

ILT/8-400		63	125	250	500	1.000	2.000	4.000	8.000
Inlet	A	64	67	71	75	78	77	73	64
	B	62	65	69	73	76	75	71	62
	C	50	57	60	64	65	65	61	52
	D	53	56	60	64	67	66	62	53
Outlet	A	63	69	74	81	83	82	78	69
	B	61	67	72	79	81	80	76	67
	C	58	64	69	76	78	77	73	64
	D	52	58	63	70	72	71	67	58
Radiated	A	61	61	63	64	62	60	57	52
	B	59	59	61	62	60	58	55	50
	C	55	55	57	58	56	54	51	46
	D	49	49	51	52	50	48	45	40

ACOUSTIC CHARACTERISTICS

The sound power spectrum in dB (A), at the fan inlet, discharge and radiated at 3 working points of the performance curve (A: maximum volume).
The sound levels shown on the curves are radiated sound pressure levels, measured at 1 m, in free field conditions.

ILT/8-450		63	125	250	500	1.000	2.000	4.000	8.000
Inlet	A	70	71	75	79	82	81	77	68
	B	68	69	73	77	80	79	75	66
	C	65	66	70	74	77	76	72	63
	D	59	60	64	68	71	70	66	57
Outlet	A	69	72	78	84	86	85	80	72
	B	69	72	78	84	86	85	80	72
	C	65	68	74	80	82	81	76	68
	D	59	62	68	74	76	75	70	62
Radiated	A	64	64	66	66	64	61	59	54
	B	63	63	65	65	63	60	58	53
	C	59	59	61	61	59	56	54	49
	D	53	53	55	55	53	50	48	43

PERFORMANCE CURVES

- q_v : Airflow in m^3/h and m^3/s .
- p_{sf} : Static pressure in mmWG and Pa.
- Dry air at $20^\circ C$ and 760 mmHg.
- Performance data in accordance with ISO 5801 and AMCA 210-99 Standards.

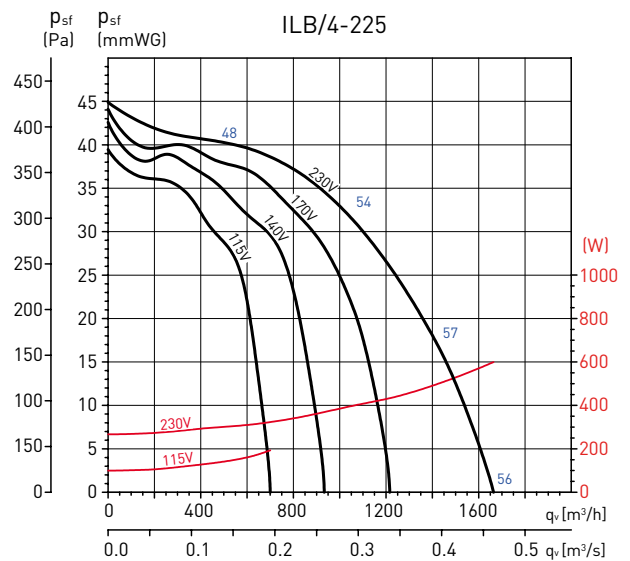
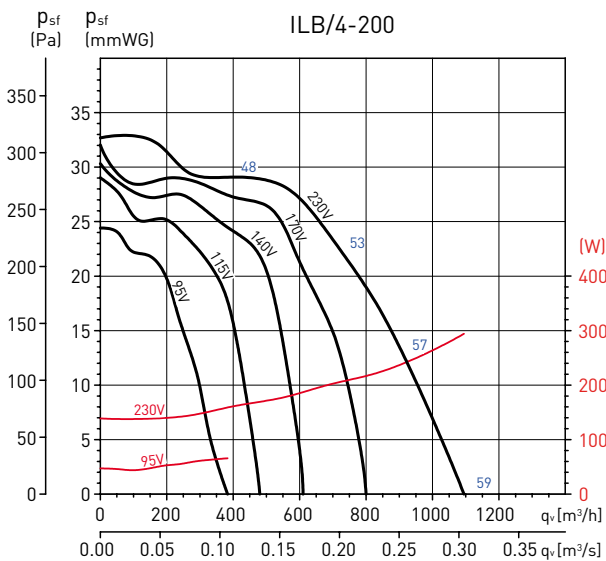

PERFORMANCE CURVES

- q_v : Airflow in m^3/h and m^3/s .
- p_{sf} : Static pressure in mmWG and Pa.
- Dry air at 20°C and 760 mmHg.
- Performance data in accordance with ISO 5801 and AMCA 210-99 Standards.

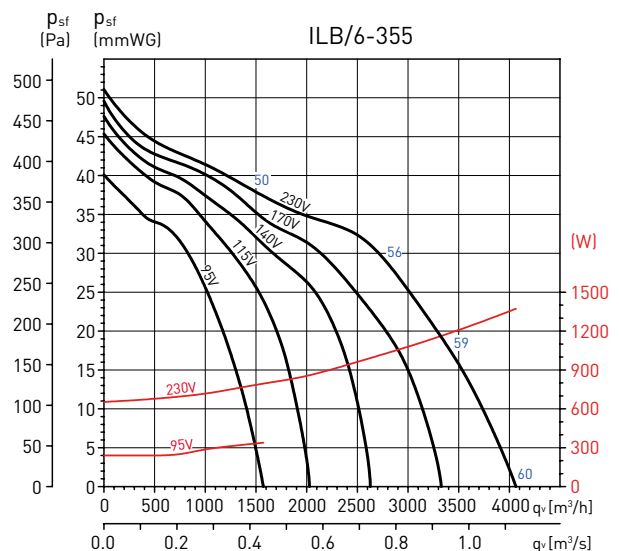
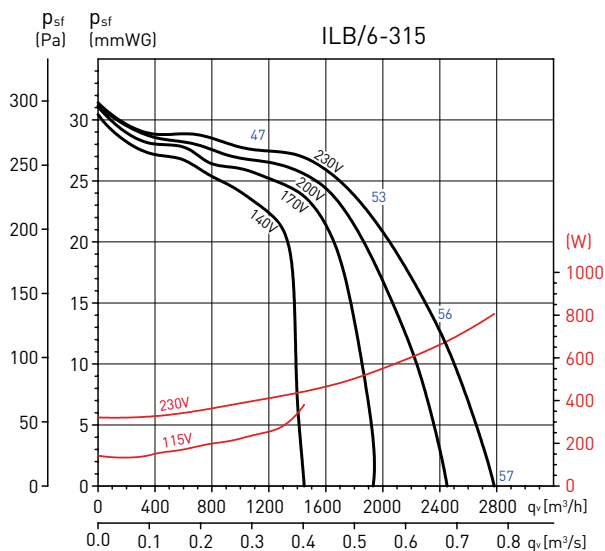
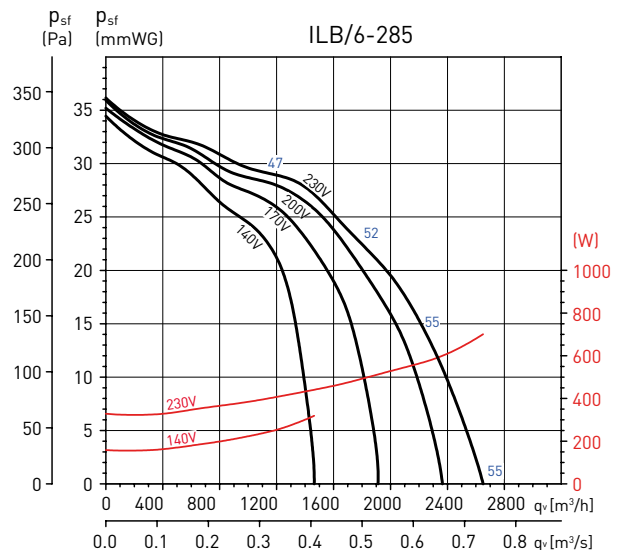
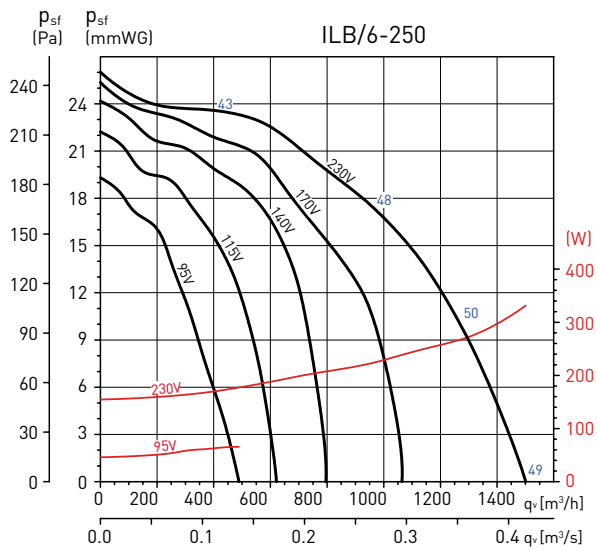
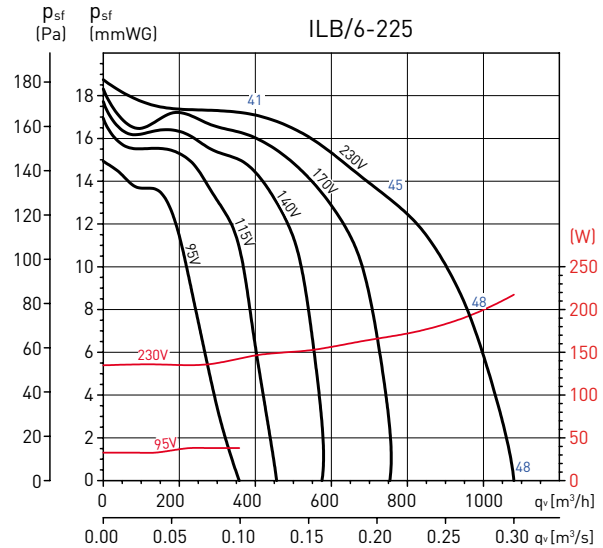
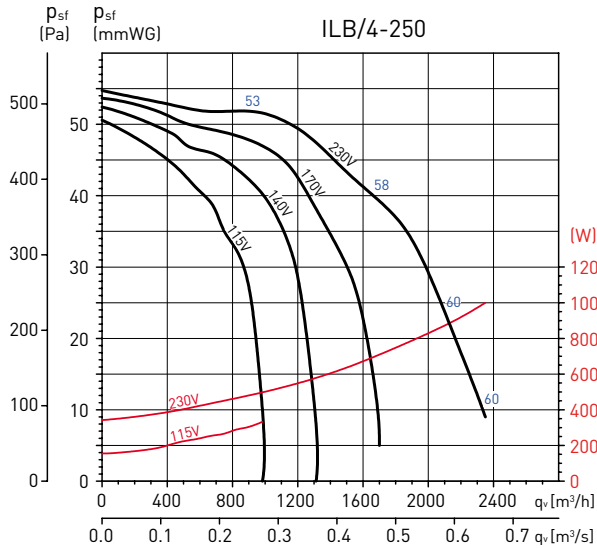

The curves shown represent different performances obtained using an RMB-RMT auto-transformer speed control.

PERFORMANCE CURVES

- q_v : Airflow in m^3/h and m^3/s .
- p_{sf} : Static pressure in mmWG and Pa.
- Dry air at $20^\circ C$ and 760 mmHg.
- Performance data in accordance with ISO 5801 and AMCA 210-99 Standards.

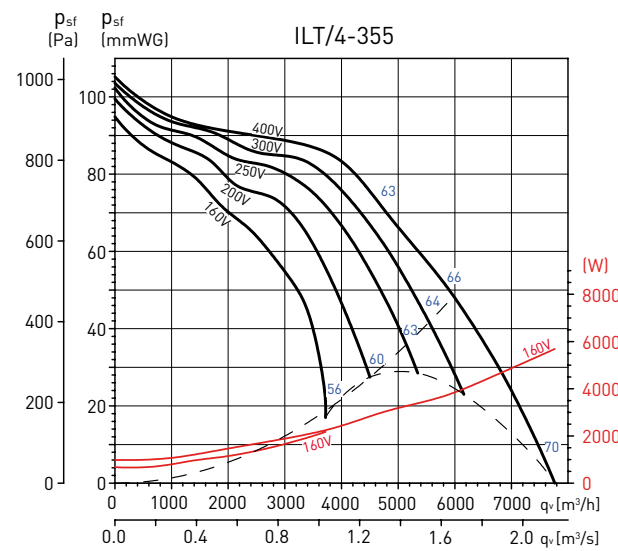
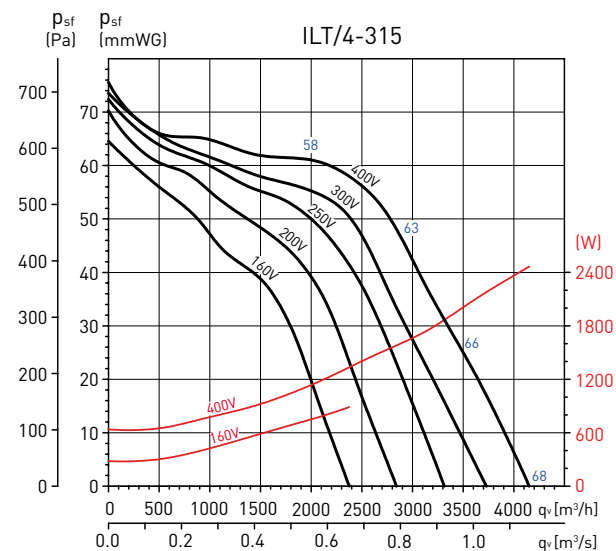
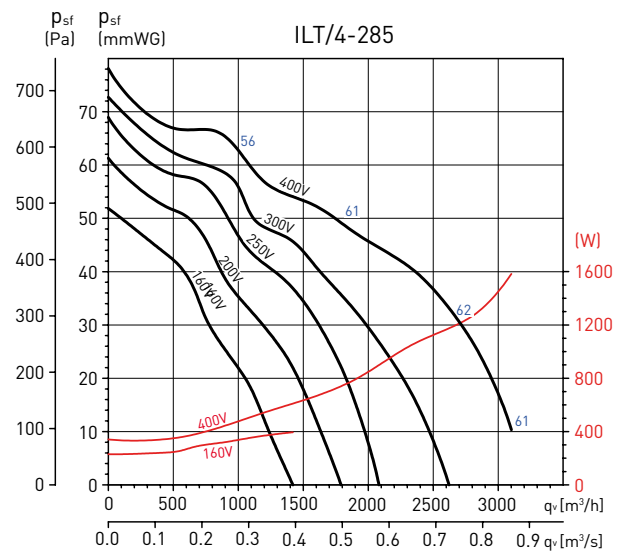
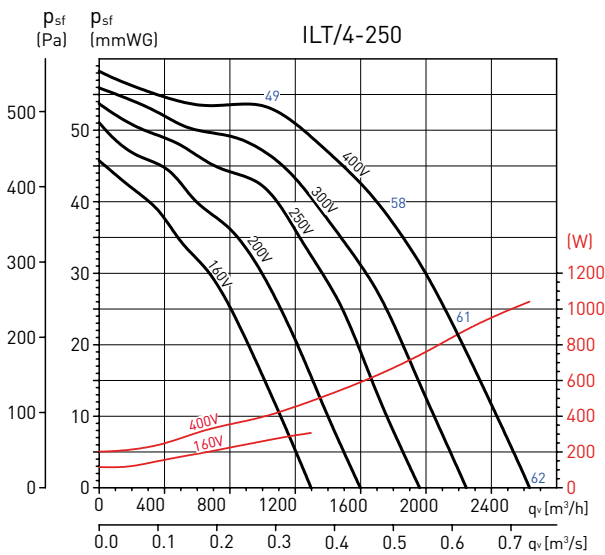
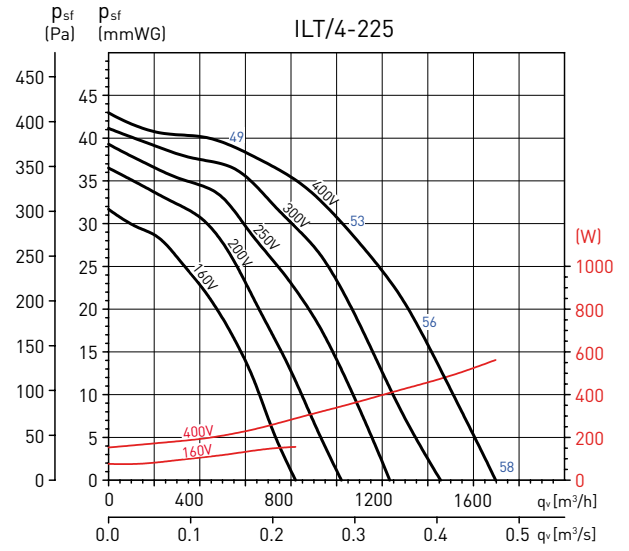
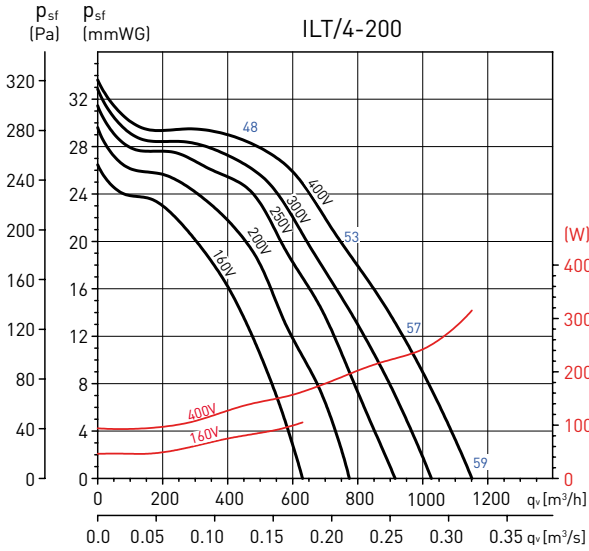

The curves shown represent different performances obtained using an RMB-RMT auto-transformer speed control.

PERFORMANCE CURVES

- q_v : Airflow in m^3/h and m^3/s .
- p_{sf} : Static pressure in mmWG and Pa.
- Dry air at $20^\circ C$ and 760 mmHg.
- Performance data in accordance with ISO 5801 and AMCA 210-99 Standards.

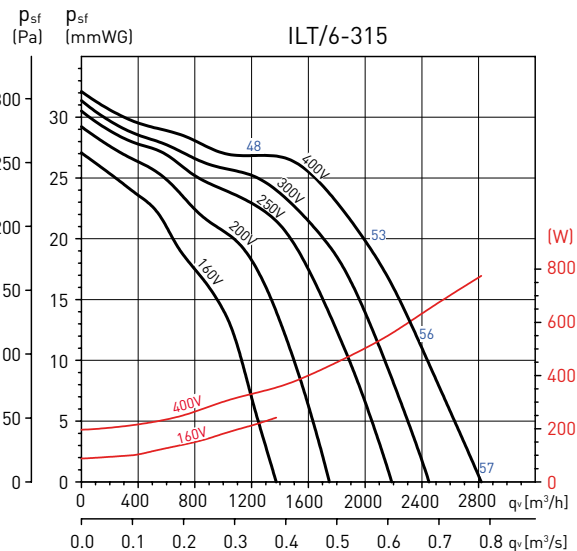
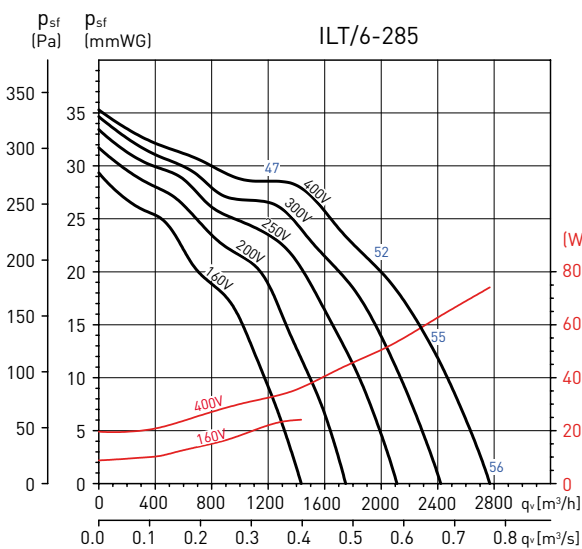
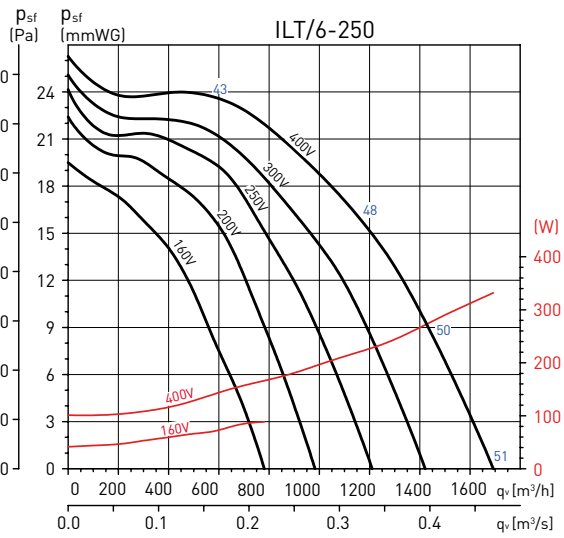
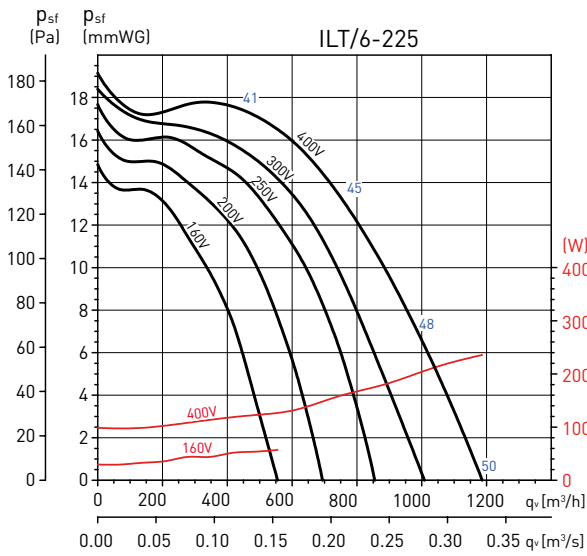
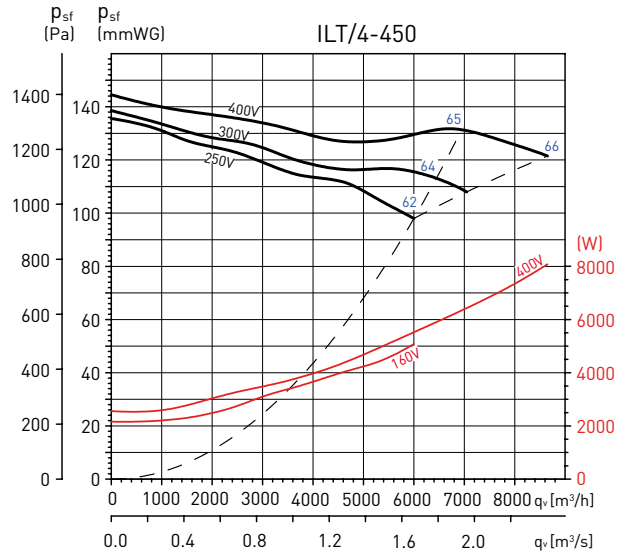
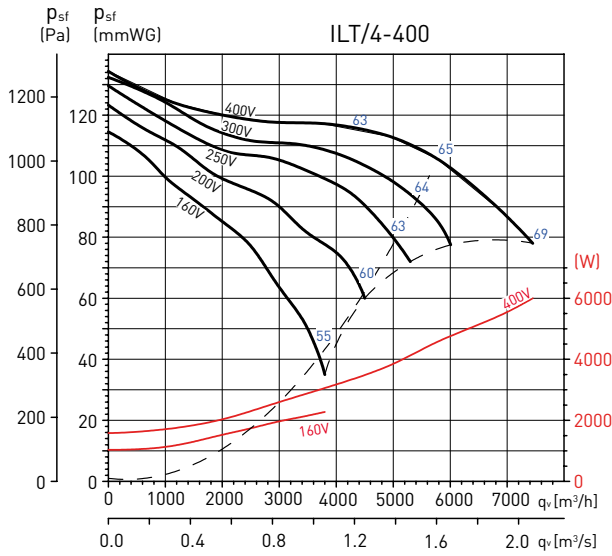

The curves shown represent different performances obtained using an RMB-RMT auto-transformer speed control.

IN-LINE RECTANGULAR DUCT FANS ILB / ILT Series



PERFORMANCE CURVES

- q_v : Airflow in m^3/h and m^3/s .
- p_{sf} : Static pressure in mmWG and Pa.
- Dry air at 20°C and 760 mmHg.
- Performance data in accordance with ISO 5801 and AMCA 210-99 Standards.

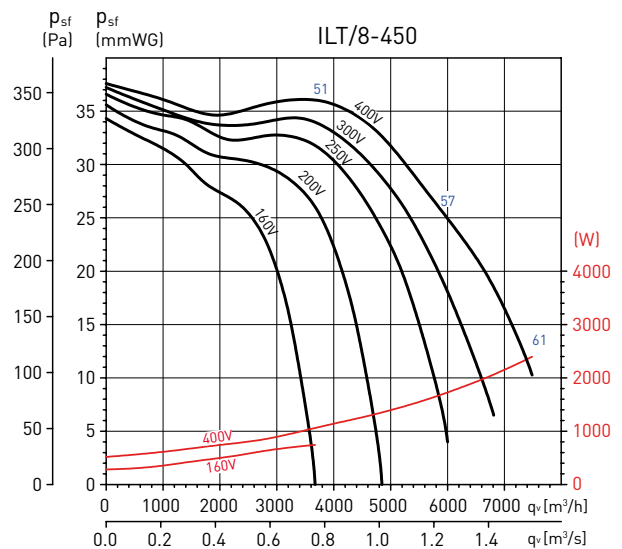
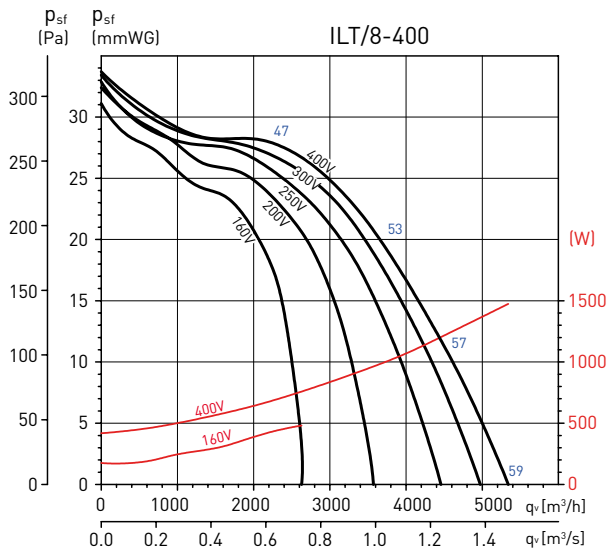
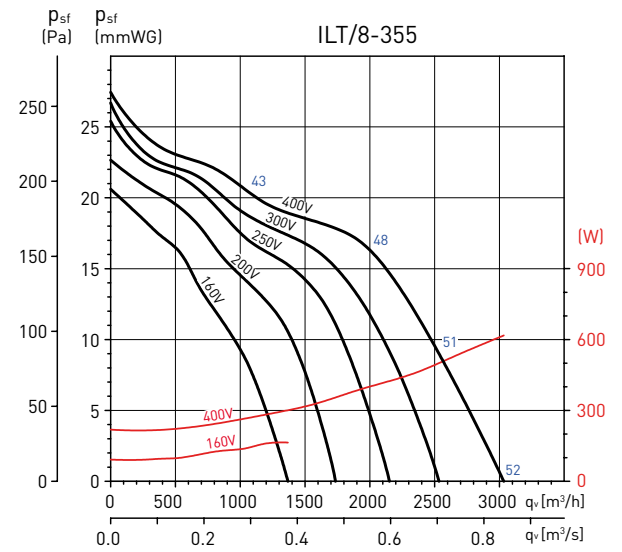
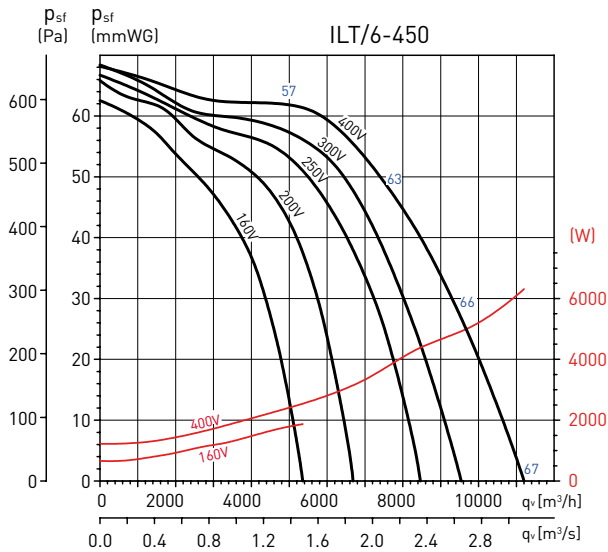
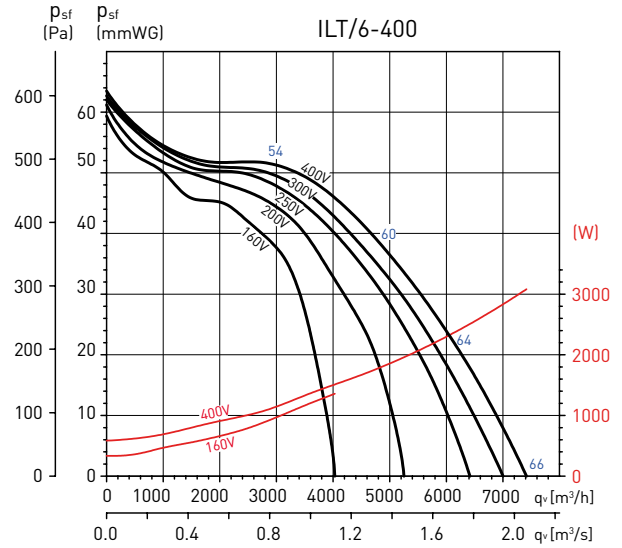
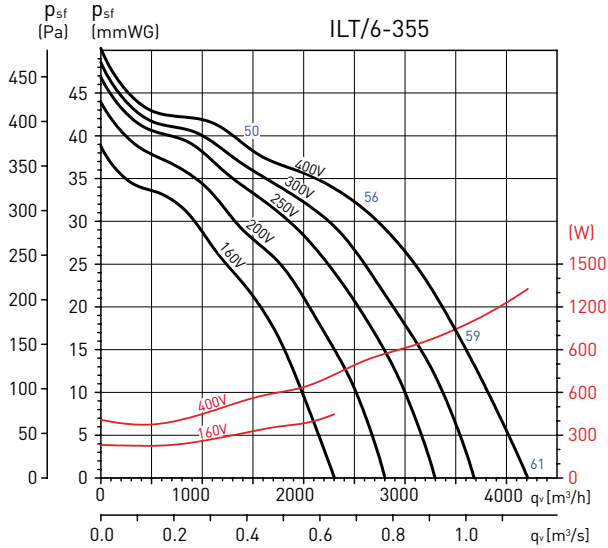

The curves shown represent different performances obtained using an RMB-RMT auto-transformer speed control.

MOUNTING ACCESSORIES

Model	Antivibration mount	Duct flange	Flexible connector	Sound attenuator	Defense guard	Damper	Filtration box G4
ILT-200	ISA	IBR-200	IAE-200	IAA-200	DEF-400x200	IJK-200	IFL-200 G4
ILT-225	ISA	IBR-225	IAE-225	IAA-225	DEF-500x250	IJK-225	IFL-225 G4
ILT-250	ISA	IBR-250	IAE-250	IAA-250	DEF-500x300	IJK-250	IFL-250 G4
ILT-285	ISA	IBR-285	IAE-285	IAA-285	DEF-600x300	IJK-285	IFL-385 G4
ILT-315	ISA	IBR-315	IAE-315	IAA-315	DEF-600x350	IJK-315	IFL-315 G4
ILT-355	ISA	IBR-355	IAE-355	IAA-355	DEF-700x400	IJK-355	IFL-335 G4
ILT-400	ISA	IBR-400	IAE-400	IAA-400	DEF-800x500	IJK-400	IFL-400 G4
ILT-450	ISA	IBR-450	IAE-450	IAA-450	DEF-1000x500	IJK-450	IFL-450 G4

Model	Filtration* box for F5,F6, F7 or F8 filters	Filter F5	Filter F6	Filter F7	Filter F8	Electric heater	Water coil
ILT-200	IFL-200 F	IFR-200 F5	IFR-200 F6	IFR-200 F7	IFR-200 F8	IBE-200/9T	IBW-200
ILT-225	IFL-225 F	IFR-225 F5	IFR-225 F6	IFR-225 F7	IFR-225 F8	IBE-225/16,5T	IBW-225
ILT-250	IFL-250 F	IFR-250 F5	IFR-250 F6	IFR-250 F7	IFR-250 F8	IBE-250/16,5T	IBW-250
ILT-285	IFL-385 F	IFR-285 F5	IFR-285 F6	IFR-285 F7	IFR-285 F8	IBE-285/20T	IBW-285
ILT-315	IFL-315 F	IFR-315 F5	IFR-315 F6	IFR-315 F7	IFR-315 F8	IBE-315/30T	IBW-315
ILT-355	IFL-355 F	IFR-355 F5	IFR-355 F6	IFR-355 F7	IFR-355 F8	IBE-355/30T	IBW-355
ILT-400	IFL-400 F	IFR-400 F5	IFR-400 F6	IFR-400 F7	IFR-400 F8	IBE-400/50T	IBW-400
ILT-450	IFL-450 F	IFR-450 F5	IFR-450 F6	IFR-450 F7	IFR-450 F8	IBE-450/63T	IBW-450



ISA
Anti-vibration
mounting
(1 ISA = 4 supports)



IBR
Rectangular duct
flange

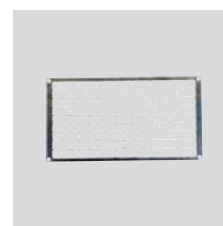

DEF
Rectangular
protection guard



IAE
Rectangular flexible connector.

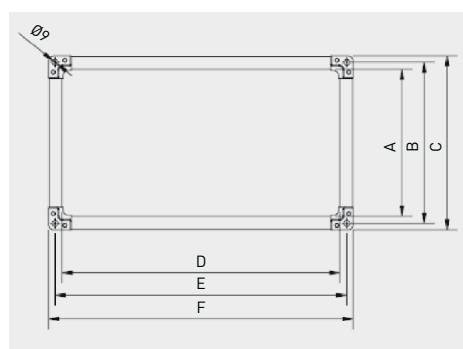

Model	A	B	C	D	E	F
IAE - 200	198	220	240	400	420	440
IAE - 225	248	270	290	500	520	540
IAE - 250	298	320	340	500	520	540
IAE - 285	298	320	340	600	620	640
IAE - 315	348	370	390	600	620	640
IAE - 355	398	420	440	700	720	740
IAE - 400	498	520	540	800	820	840
IAE - 450	498	520	540	1000	1020	1040

MOUNTING ACCESSORIES



IAA
Sound attenuators
 Designed to reduce in-duct sound levels.
 All models are designed in 1m length.

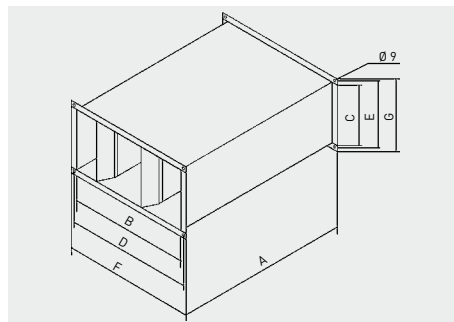
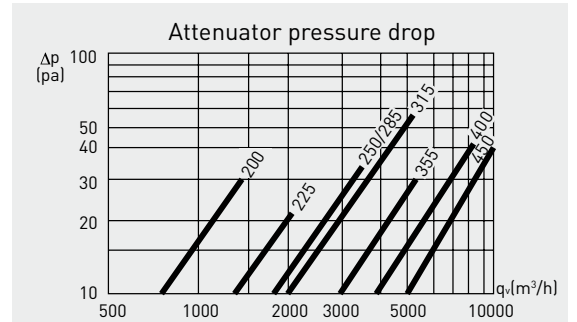
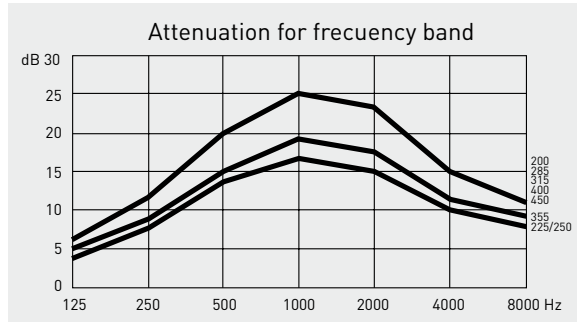

Model	A	B	C	D	E	F	G	Weight
IAA-200	1000	400	200	420	220	440	240	18,6 kg
IAA-225	1000	500	250	520	270	540	290	23,0 kg
IAA-250	1000	500	300	520	320	540	340	23,0 kg
IAA-285	1000	600	300	620	320	640	340	28,2 kg
IAA-315	1000	600	350	620	370	640	390	30,0 kg
IAA-355	1000	700	400	720	420	740	440	34,6 kg
IAA-400	1000	800	500	820	520	840	540	44,2 kg
IAA-450	1000	1000	500	1020	520	1040	540	56,0 kg



IJK
Damper
 Supplied with standard rectangular flanges.
 Manufactured from galvanised sheet steel.
 Fitted as standard with removable handle.
 Shaft diameter: 10 mm.
 As accessory: electrical damper actuator LM230A.

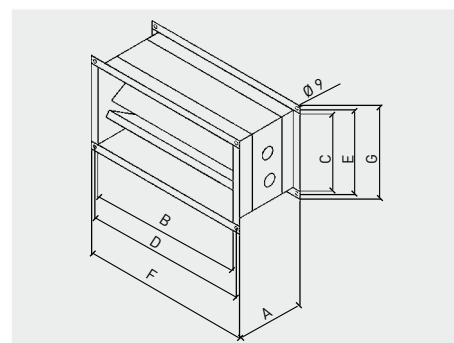
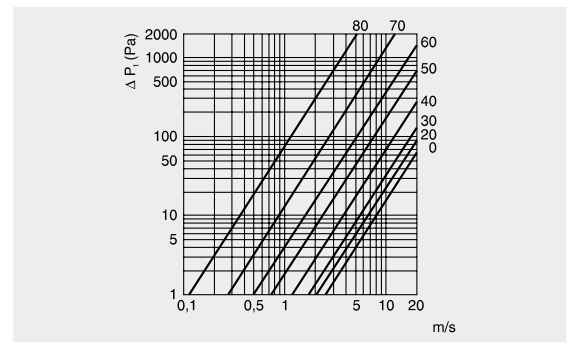

Model	A	B	C	D	E	F	G	Weight
IJK-200	162	400	200	420	220	440	240	3,3 kg
IJK-225	162	500	250	520	270	540	290	4,2 kg
IJK-250	162	500	300	520	320	540	340	4,9 kg
IJK-285	162	600	300	620	320	640	340	5,4 kg
IJK-315	162	600	350	620	370	640	390	5,8 kg
IJK-355	162	700	400	720	420	740	440	7,1 kg
IJK-400	162	800	500	820	520	840	540	9,2 kg
IJK-450	162	1000	500	1020	520	1040	540	11,0 kg

MOUNTING ACCESSORIES



IFL-G4
Filtration box with IFR-G4 filters incorporated
Casing manufactured from galvanised sheet steel and provided with G4 filter type. Supplied with standard rectangular flanges. Access door to ease filter replacement. Can be fitted in any position. Working temperature up to 80°C. Maximum recommended differential pressure: 200Pa. Spare filter: IFR .. G4. As accessory: Differential pressure switch (DPS 2-30 pressure switch - 20 to 300Pa).

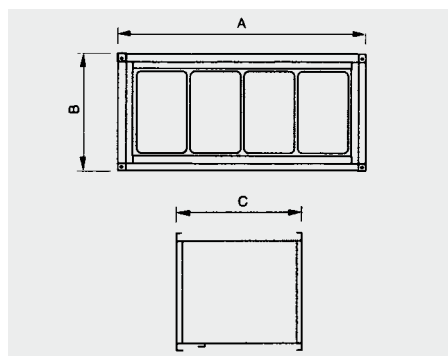
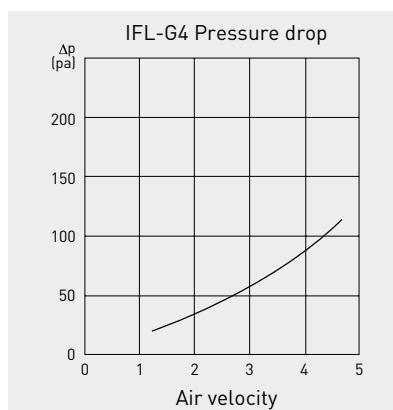

Model	A	B	C	Weight	Spare filter
IFL-200 G4	440	240	190	3,5 kg	IFR-200 G4
IFL-225 G4	540	290	190	4,0 kg	IFR-225 G4
IFL-250 G4	540	340	190	4,5 kg	IFR-250 G4
IFL-285 G4	640	340	190	5,0 kg	IFR-285 G4
IFL-315 G4	640	390	190	5,5 kg	IFR-315 G4
IFL-355 G4	740	440	190	6,0 kg	IFR-355 G4
IFL-400 G4	840	540	190	7,5 kg	IFR-400 G4
IFL-450 G4	1040	540	190	9,0 kg	IFR-450 G4



IFL-F filtration box.



IFL-F filtration box with IFR-F filter installed.

IFL-F
Filtration box (Casing supplied without filter) to install IFR-F filters.
Casing manufactured from galvanised sheet steel, supplied without filter and used to mount IFR filter type. Supplied with standard rectangular flanges. Access door to mount the IFR filter and to ease filter replacement. Can be fitted in any position. Differential pressure switch as accessory (DPS 2-30 and 10-100 pressure switches - 20 to 300Pa and 100 to 1000Pa)

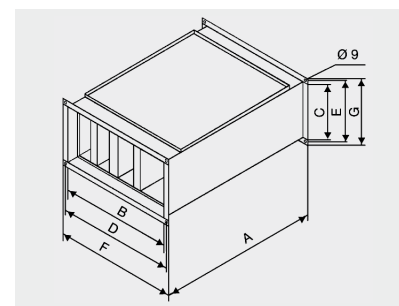

Model	A	B	C	D	E	F	G	Weight	Filter type			
IFL-200 F	580	400	200	420	220	440	240	7,8 kg	IFR-200 F5	IFR-200 F6	IFR-200 F7	IFR-200 F8
IFL-225 F	580	500	250	520	270	540	290	9,2 kg	IFR-225 F5	IFR-225 F6	IFR-225 F7	IFR-225 F8
IFL-250 F	580	500	300	520	320	540	340	10,0 kg	IFR-250 F5	IFR-250 F6	IFR-250 F7	IFR-250 F8
IFL-285 F	580	600	300	620	320	640	340	11,4 kg	IFR-285 F5	IFR-285 F6	IFR-285 F7	IFR-285 F8
IFL-315 F	580	600	350	620	370	640	390	12,0 kg	IFR-315 F5	IFR-315 F6	IFR-315 F7	IFR-315 F8
IFL-355 F	580	700	400	720	420	740	440	11,8 kg	IFR-355 F5	IFR-355 F6	IFR-355 F7	IFR-355 F8
IFL-400 F	580	800	500	820	520	840	540	16,8 kg	IFR-400 F5	IFR-400 F6	IFR-400 F7	IFR-400 F8
IFL-450 F	580	1000	500	1020	520	1040	540	18,8 kg	IFR-450 F5	IFR-450 F6	IFR-450 F7	IFR-450 F8

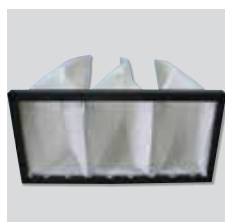

IFR-F
Filters to install IFL-F filtration box

Filter IFR-F5
Class filter grade F5 (EU5).
Maximum working temperature 80° C.
Maximum recommended differential pressure 450 Pa.

Filter IFR-F6
Class filter grade F6 (Eu6).
Maximum working temperature 80° C.
Maximum recommended differential pressure 450 Pa.

Filter IFR-F7
Class filter grade F7 (EU7).
Maximum working temperature 80° C.
Maximum recommended differential pressure 450 Pa.

Filter IFR-F8
Class filter grade F8 (Eu8).
Maximum working temperature 80° C.
Maximum recommended differential pressure 450 Pa.

Filtration box IFR-F with filter mounted - Pressure drops

IFL-200

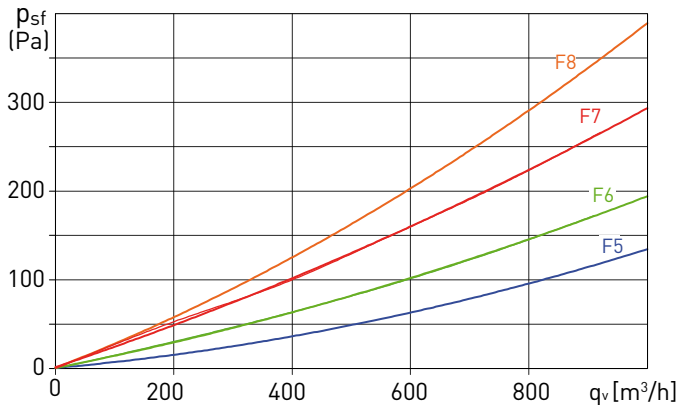

IFL-225

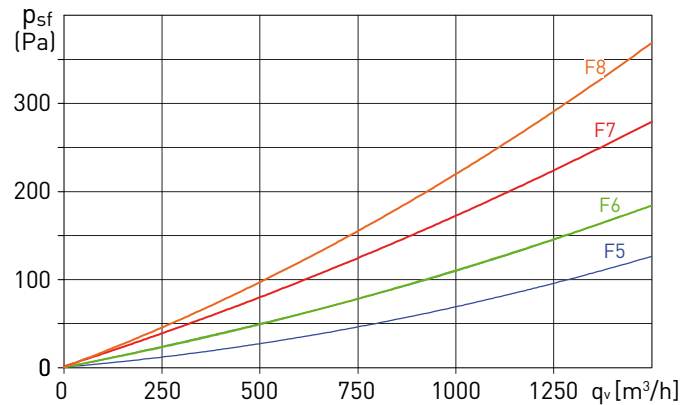

IFL-250

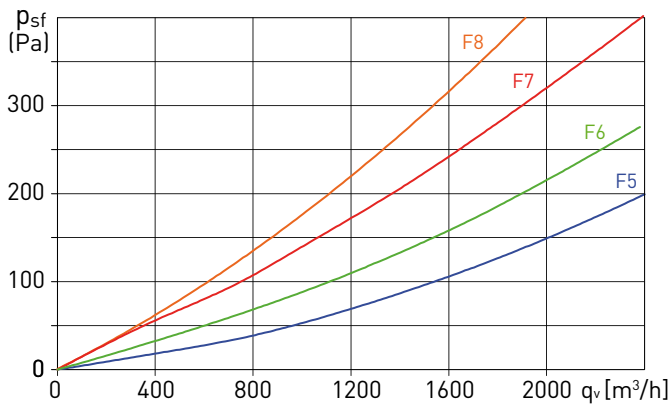

IFL-285

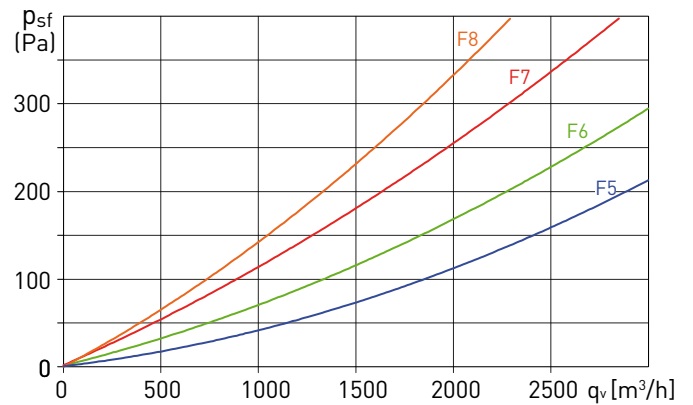

IFL-315

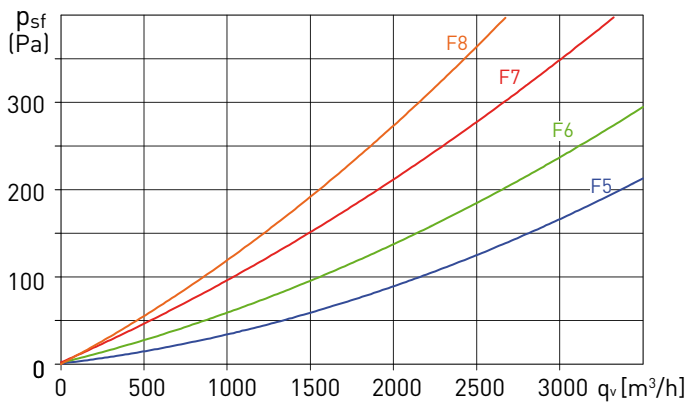

IFL-355

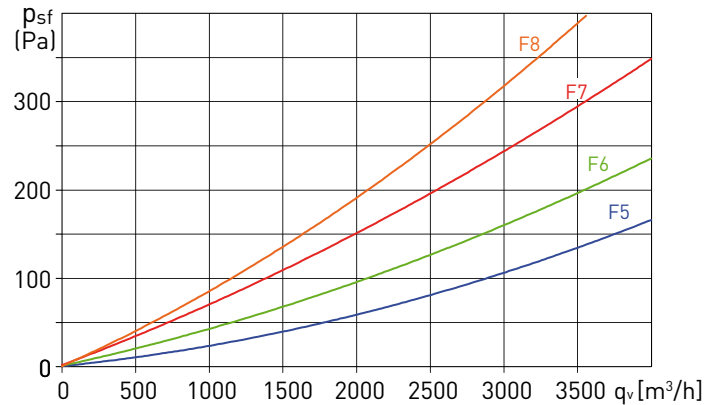

IFL-400

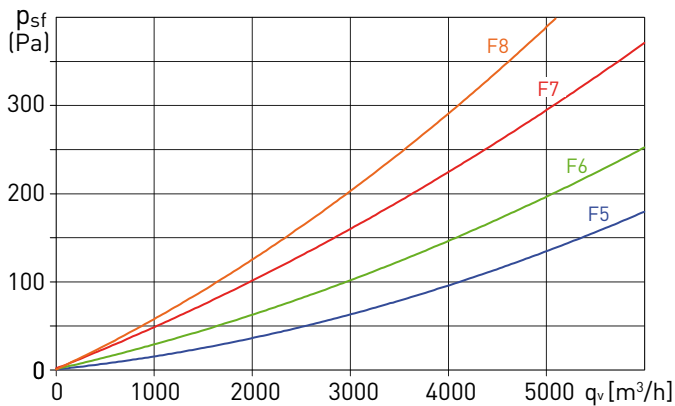

IFL-450

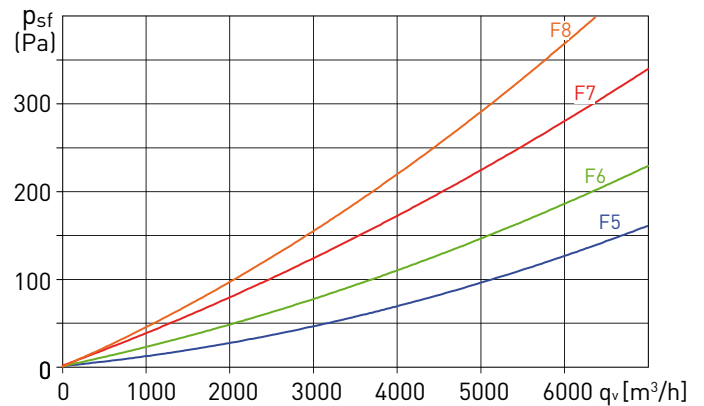

MOUNTING ACCESSORIES



IBE
Electric heater
 For more information see Heating range.



IBW
Hot water coil
 Casing manufactured from galvanised sheet steel.
 Copper tubes and aluminium fins.
 Supplied with standard rectangular flanges.
 Can be fitted in horizontal or vertical position.
 Maximum water pressure 16bar.
 Maximum water temperature: 120°C.
 As accessory: Filtration box and pressure switch to reduce and control the coil clogging.

Model	Air				Airflow (m³/h)	Water		Weight (kg)	Duct coil (Inch)	Accessories		
	Power		Δ T air			Pressure (kPa)*	Volume (l/h1)			Coil mounting kit		Thermostat (***)
	KW1)	KW2)	(°C)*	(°C)**						Model	Setting	
IBW-200-2	10,1	5,9	25,9	15,1	1.152	1,2	435	6	3/4"	PWW-SE1	1	THE 16/4 A
IBW-200-4	17,6	11,5	45,1	29,4	1.152	3	756	7	3/4"	PWW-SE1	1	THE 16/4 A
IBW-225-2	16,5	10,2	27	16,8	1.800	2,2	709	7	3/4"	PWW-SE1	1	THE 16/4 A
IBW-225-4	28,3	18,9	46,5	31,1	1.800	5,9	1.213	10	3/4"	PWW-SE1	2	THE 16/4 A
IBW-250-2	19,8	12,3	27	16,8	2.160	2,2	853	8	3/4"	PWW-SE1	1	THE 16/4 A
IBW-250-4	33,6	22,3	46	30,5	2.160	4,8	1.443	11	1"	PWW-SE3	2	THE 16/4 A
IBW-285-2	24,4	15,6	27,8	17,8	2.592	3,6	1.051	9	3/4"	PWW-SE1	2	THE 16/4 A
IBW-285-4	41	27,6	46,8	31,5	2.592	7,8	1.760	12	1"	PWW-SE3	3	THE 16/4 A
IBW-315-2	28,4	18,2	27,8	17,8	3.024	3,6	1.228	10	3/4"	PWW-SE1	2	THE 16/4 A
IBW-315-4	48	32,4	46,9	31,7	3.024	8,3	2.063	13	1"	PWW-SE3	3	THE 16/4 A
IBW-355-2	42,2	26,5	31	19,4	4.032	2,9	1.821	14	1"	PWW-SE3	3	THE 16/4 A
IBW-355-3	57,8	36,5	42,4	26,8	4.032	2,4	2.476	16	1"	PWW-SE3	3	THE 16/4 A
IBW-400-2	62,2	40,2	31,9	20,6	5.760	4,9	2.685	20	1"	PWW-SE3	3	THE 16/4 A
IBW-400-4	84,5	54,5	43,4	28	5.760	3,7	3.628	25	1"	-	-	-
IBW-450-2	79,8	52,7	32,8	21,6	7.200	8,7	3.424	23	1"	-	-	-
IBW-450-4	122	82,6	42	28	7.200	6,7	5.370	28,2	1"	-	-	-

Outdoor temperature 0°C and water temperature: *80/60°C - **60/40°C *** When the motor pump is not connected directly to the hot-water boiler.

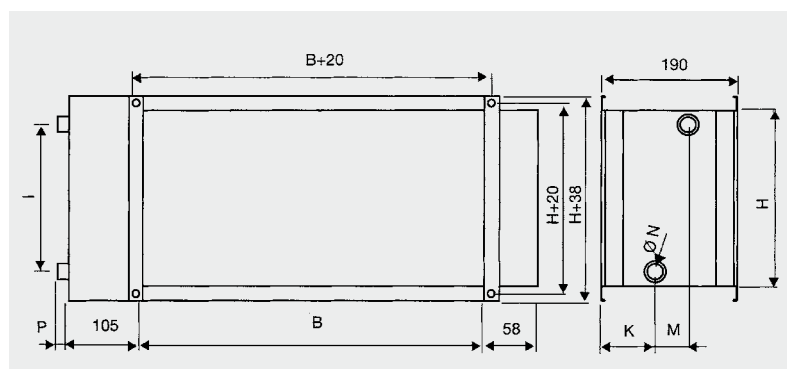

Model	B	H	I	K	M	P
IBW-200	400	200	150	84	43	28
IBW-225	500	250	200	62	65	28
IBW-250	500	300	250	84	43	28
IBW-285	600	300	250	62	65	35
IBW-315	600	350	230	84	43	28
IBW-355	700	400	350	66	58	35
IBW-400	800	500	450	82	47	35
IBW-450	1000	500	450	66	58	35

MOUNTING ACCESSORIES

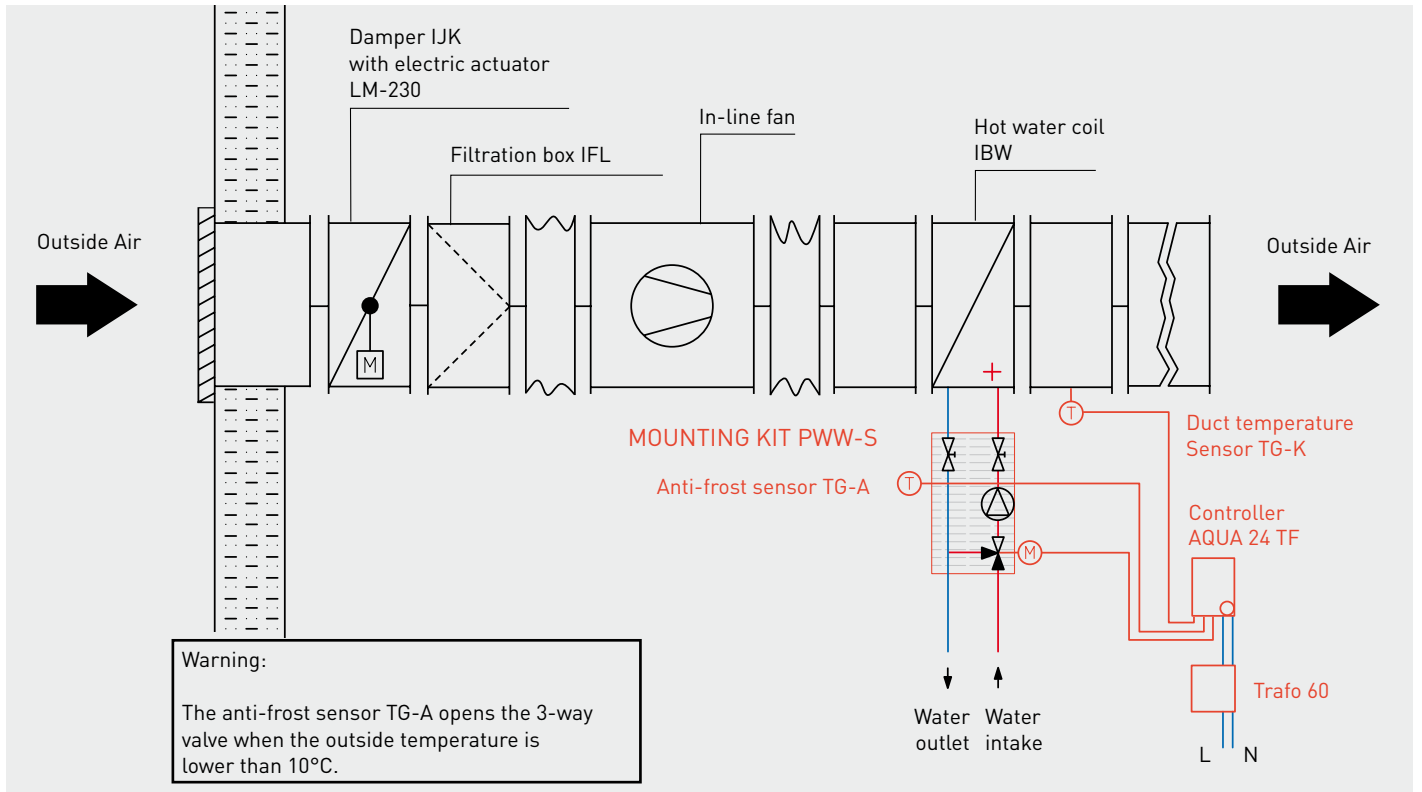

Hot water coils - Air temperature increase and pressure drops

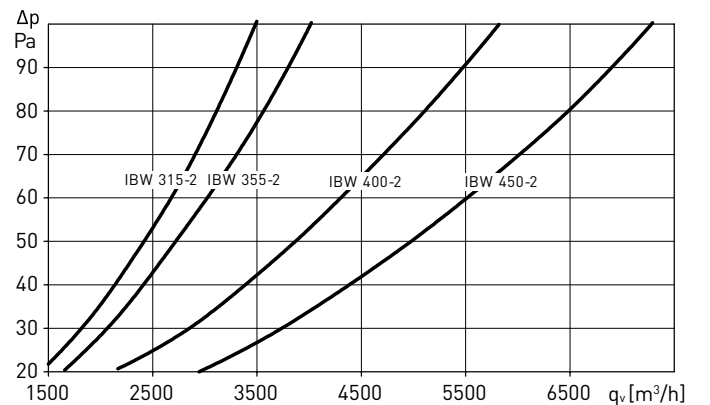
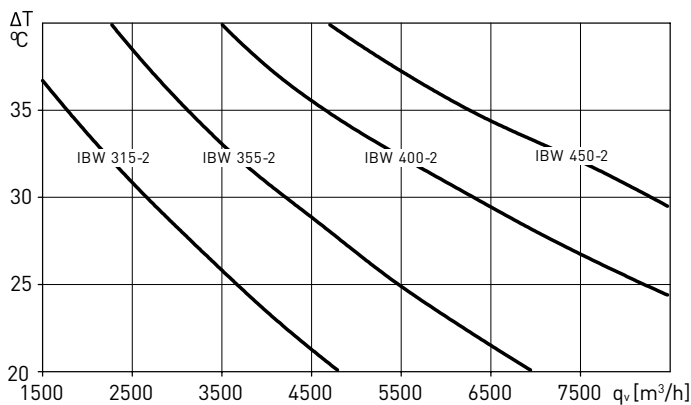
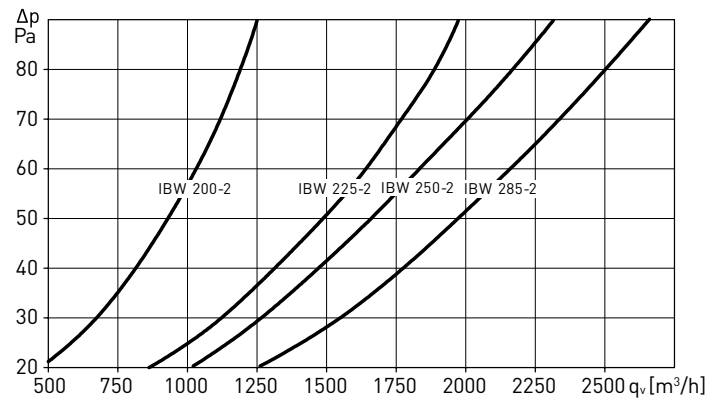
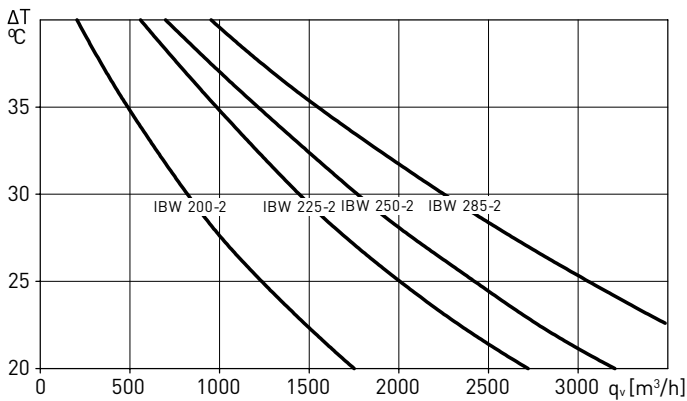

MOUNTING ACCESSORIES

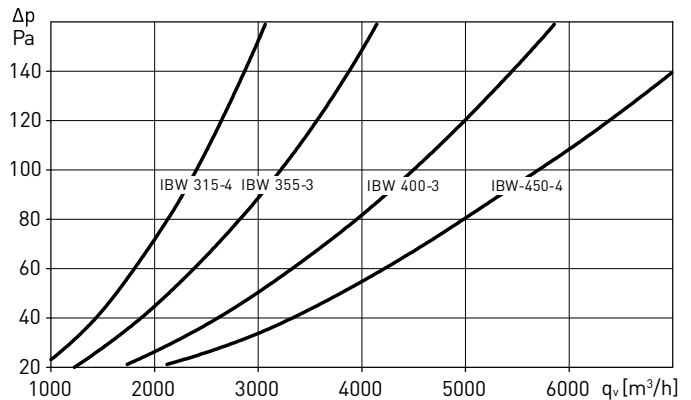
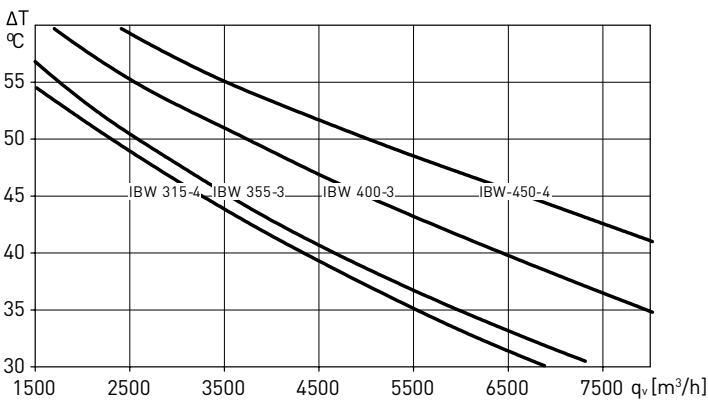
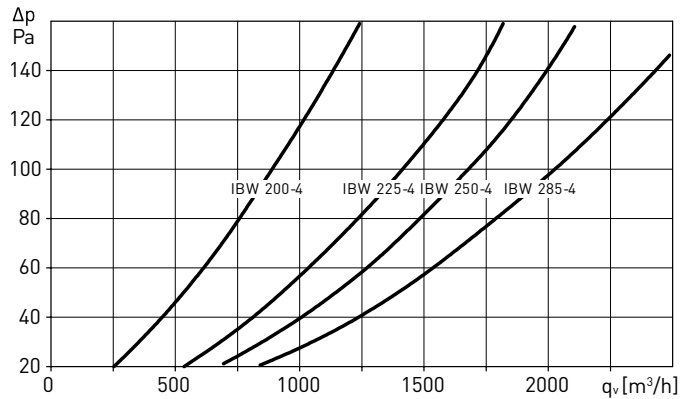
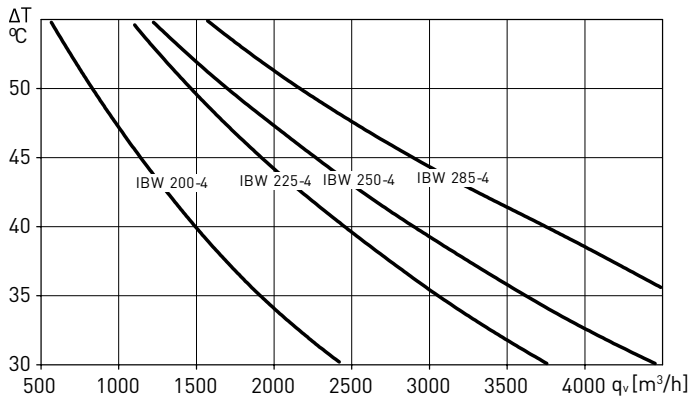

PWW
Complete mounting kit for hot water coil
For more information see Electrical accessories.

ELECTRICAL ACCESSORIES



RMB/RMT
Fan speed controllers.



DPS 2-30
DPS 10-100
Differential pressure switches:
- DPS 2-30: from 20Pa to 300Pa.
- DPS 10-100: from 100Pa to 1000Pa.



LM-230A
Electrical damper actuator.



TTC-2000
TTC-2000 + TTS-1
Three phase electric heater controller. The TTC-2000 needs an external temperature sensor to control the heater (TG-K300 or TG-R530).



TTC-40F + TTS-4
Three phase electric heater controller. The TTC-40F needs an external temperature sensor to control the heater (TG-K300 or TG-R530).



TG-K330
Duct temperature sensor.
TG-R530
Room temperature sensor.

For more information see Electrical accessories.